

# FTL Test Blocks

## Reference Handbook

FTL-reference-en v.181

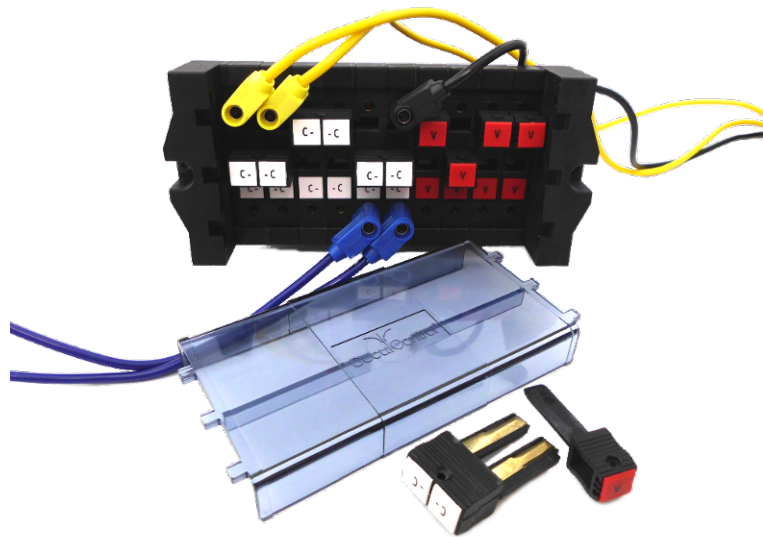

## **Copyright Notice**

All information provided in this document is the property of **SECUCONTROL** .

**SECUCONTROL** grants its customers or potential customers the right to download, copy, store and print this document for the sole purpose of assisting them in the correct application of the products mentioned in this document.

All other uses of this document are expressly prohibited.

## **Intellectual Property Notice**

This publication contains proprietary information under protection of the following (among others) patents: DE 10 2005 025 108, DE 10 2008 016 388, US 7,271,357 and US 7,884,597.

## **Contents Disclaimer**

Although the information and recommendations in this document are presented in good faith and believed to be correct as of publication date, **SECUCONTROL** makes no representations as to the completeness or accuracy thereof. In no event shall **SECUCONTROL** be responsible for damages of any nature resulting from the use of or reliance upon the contents of this document.

## **Continuous Improvements**

Products developed by **SECUCONTROL** are continuously improved. The information in this document may, therefore, be out of date.

Please make sure you have the latest release of this document before proceeding by checking its name and revision code. This information is printed on the front cover of this document, underneath the title. The latest release of this document can be downloaded from [www.secucontrol.com/downloads](http://www.secucontrol.com/downloads). Alternatively, you may contact **SECUCONTROL** at any of the addresses provided on the rear cover of this document.

# Contents

<b>1</b>	<b>Introduction</b>	<b>1</b>
	The FTL Test Block . . . . .	1
	Key Features . . . . .	1
	Applicable Models . . . . .	1
	Unpacking . . . . .	1
	Part Number and Manufacturing Date Location . . . . .	2
	Safety Symbols . . . . .	2
	General Safety Instructions . . . . .	2
<b>2</b>	<b>Principle of Operation</b>	<b>3</b>
	Closed Circuit . . . . .	3
	Open Circuit . . . . .	3
	Signal Injection . . . . .	3
<b>3</b>	<b>Application</b>	<b>5</b>
	Schematic Symbols . . . . .	5
	Typical Connection Schematic . . . . .	6
<b>4</b>	<b>Installation</b>	<b>7</b>
	Panel Cutouts, Drilling Plans and Mounting . . . . .	7
	Wiring . . . . .	8
<b>5</b>	<b>Operation</b>	<b>11</b>
<b>6</b>	<b>Technical Specifications</b>	<b>13</b>
	Electrical . . . . .	13
	Mechanical . . . . .	13
	Dimensional Drawings . . . . .	14
<b>7</b>	<b>Models Available</b>	<b>17</b>
	Number of banana jacks . . . . .	17
<b>8</b>	<b>Accessories</b>	<b>19</b>
	Adapters for use with Insulated Banana Plugs . . . . .	19
	Adapters for use with Wide Test Leads . . . . .	19
	Jumper Cable . . . . .	19
	Current Measurement Probe . . . . .	20
	FTL 19" Rack Plates . . . . .	20
	Covers for 19" FTL Rack Plate Cutouts . . . . .	22

<b>9 Spare Parts</b>	<b>23</b>
Disconnect Pins . . . . .	23
Dust Covers . . . . .	23
Fitting Set . . . . .	23
<b>10 Ordering Information</b>	<b>25</b>
Part Numbers . . . . .	25
Available Configurations . . . . .	25

# 1 Introduction

## The FTL Test Block

The FTL is a test block for interfacing substation devices (protection relays, fault recorders, revenue meters, ...) to the voltage and current transformers and to other equipment on the system side of a power grid.

The FTL Test Block uses Disconnect Pins to isolate the substation devices from the system side equipment. Once isolated, secondary injection can be performed using banana jacks on the front side of the Test Block.

## Key Features

- Finger-safe Test Block and Disconnect Pins increase safety during testing.
- Disconnect Pins are keyed to the corresponding parts of the Test Blocks, preventing mistakes and errors during test.
- Extremely low internal resistance ( $< 2 \text{ m}\Omega$ ) helps reduce heat inside cabinets and panels.
- Available in 8, 10, 12, 14, 16, 18 or 20 pole configurations.

## Applicable Models

Information in this document applies to all FTL Test Blocks manufactured after May 2011.

## Unpacking

Unpack the product carefully and make sure that all pertinent parts like dust covers and screws are put aside so they will not be lost.

Check the contents against the packing list. If any of the contents listed are missing, please contact **SECUCONTROL** immediately (see contact information at the rear cover of this manual).

Examine the product for any shipping damage. If the product is damaged, notify the shipping company without delay. Only the consignee (the person or company receiving the unit) can file a claim against the carrier for shipping damage.

## Part Number and Manufacturing Date Location

Part number and manufacturing date are stated on a label on the right side of the Test Block.

## Safety Symbols

The following symbols are located on different parts of the equipment and in this manual:



Paragraphs marked with this symbol contain information which, if not properly followed, may cause damage to the equipment and/or installation.



Paragraphs marked with this symbol contain information which, if not properly followed, may cause personal injury or even death.

---

## General Safety Instructions

Installation and operation of the products described in this manual is only to be performed by personnel that has been trained or is knowledgeable in substation protection, automation and control.

This instruction manual is an integral part of the scope of delivery and provides basic instructions for installation and operation of the equipment here described. Shall additional information be needed, please contact **SECUCONTROL** at any of the addresses provided on the rear cover of this document.



Do not disassemble the Test Block. Correct alignment of internal parts is critical in order to provide insulation and arch-avoidance.



The warranty will be void if the Test Block is disassembled (or otherwise handled inappropriately). **SECUCONTROL** does not assume responsibility for any damages arising out of mishandling of our products, including test blocks that have been disassembled by parties other than SecuControl.

# 2 Principle of Operation

## Closed Circuit

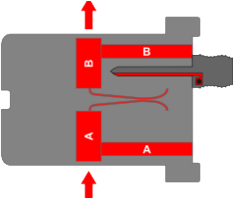

In the resting state the contacts of the FTL Test Block are closed. In this situation, the signals from the system side of the installation (side A) are connected to the measuring and protection devices (side B).

## Open Circuit

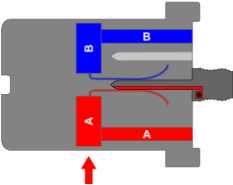

To open the Test Block's contacts, the disconnect pins are moved from the parking position to the test position. In this situation, the devices on the B-side are insulated from the installation side.

## Signal Injection

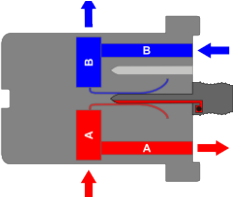

With the disconnect pins in the test position, signal injection can be performed using the banana jacks on the front side of the Test Block.





# 3 Application

## Schematic Symbols

Following symbols are suggested in order to represent the FTL Test Block in schematic diagrams.

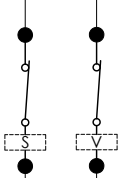
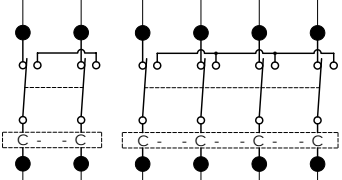
Symbol	Description
	Signal, Voltage (single pole)
	Current (2-pole, 4-pole)



# 4 Installation

## Panel Cutouts, Drilling Plans and Mounting

Use the provided M5x30 screws to fix the FTL Test Block onto the panel. The screws should be tightened using a 4 mm hex drive.

### 8-pole Models

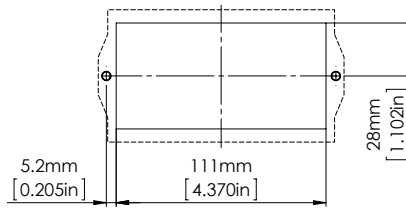

### 10-pole Models

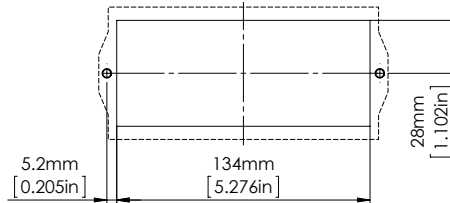

### 12-pole Models

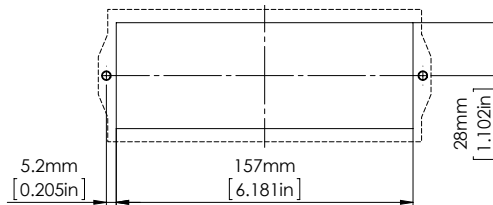

## 4. INSTALLATION

---

### 14-pole Models

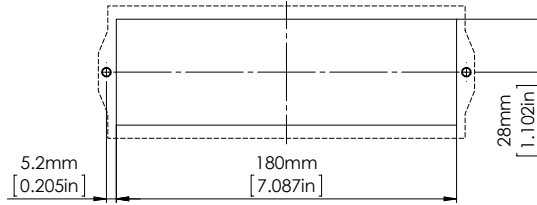

### 16-pole Models

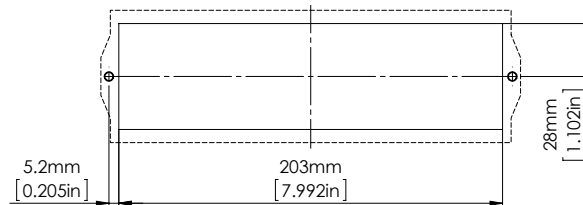

### 18-pole Models

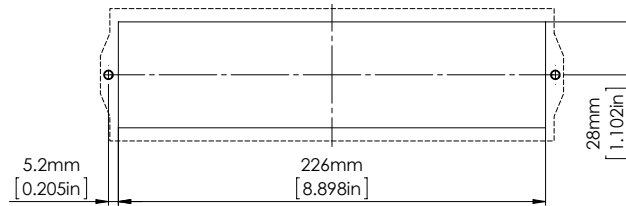

### 20-pole Models

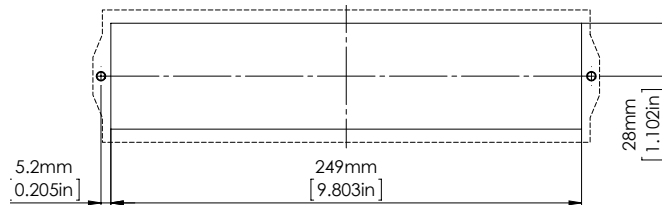

### Wiring

Electrical connection terminals are located on the top and bottom of the FTL Test Block. The connection terminals combine a screw in the center with a pressure plate, accepting ring cable lugs, stripped wire or other crimp connectors.

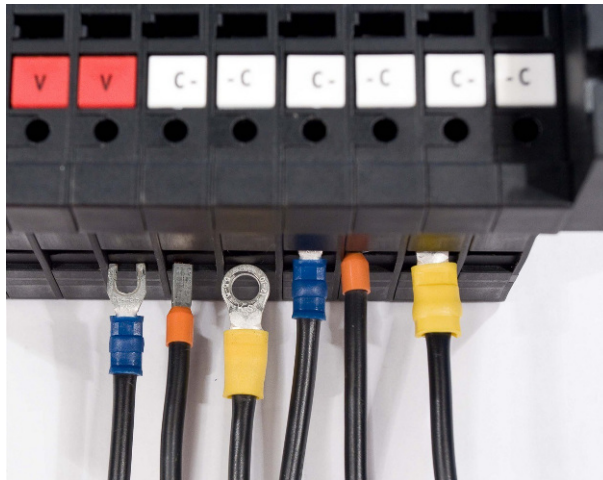

Recommended wire gauge is from 1.5 mm<sup>2</sup> (AWG 16) to 4 mm<sup>2</sup> (AWG 12).

CTs should be wired to the terminals provided for this purpose (in 2- or 4-pole combinations) to ensure automatic short circuiting upon insertion of the Disconnect Pins. The terminals designated for the connection of the CTs can be typically identified by the 

C-	-C
----	----

 or 

C-	-C-	-C-	-C
----	-----	-----	----

 labeling<sup>1</sup>.

The panel equipments (protection relays, meters, fault recorders, etc) should be connected to the device side terminals indicated by the odd-numbers (1, 3, 5, 7, ...), or by the “b” suffix (1b, 2b, 3b, ...), depending on model.

The protection equipments (current and voltage transformers, breaker, etc) should be connected to the system side terminals indicated by the even-numbers (2, 4, 6, 8, ...), or by the “a” suffix (1a, 2a, 3a, ...), depending on model.



<sup>1</sup>Custom labeling may show other symbols or use other colors.



## 5 Operation

Handling of Disconnect Pins should be done using only its plastic part, since the fingers may be connected to live equipment either via the test block or test equipment.



1. Remove the dust cover by sliding the cover up and then out.
2. Remove the FTL Disconnect Pins one-by-one from the parking position and insert them into the corresponding circuit's testing position.

There is no need to externally short-circuit the current transformers, since the 2- and 4- pole current Disconnect Pins have an integrated shorting bar which will automatically short circuit the corresponding circuits before opening it.

Notice that the dust cover can't be reattached to the Test Block if any of the Disconnect Pins is in the testing position. This is intentional and provides a visual flag that testing is being performed.

3. For signal injection, connect the test set via the banana jacks in the FTL Test Block. This step is entirely based on your normal testing procedures, and should be planned and carefully executed by a trained technician.
4. Once you are ready to resume normal operation, remove the Disconnect Pins from the testing position and insert them back into the parking position.
5. Reattach the dust cover once all Disconnect Pins are returned to the parking position.





## 6 Technical Specifications

### Electrical

Current Withstand	30 A continuously 500 A for 1 second
Maximum voltage	600 V
Contact resistance	$\leq 2 \text{ m}\Omega$
Dielectric Withstand	3.0 kV RMS for 1 minute between adjacent contact pairs and between any contact pair and other metal parts 2.0 kV RMS for 1 minute between open contacts when test pin is inserted
Voltage Impulse	3 positive and 3 negative impulses of 5 kV peak, 1.2/50 $\mu\text{s}$ , 0.5 J between adjacent contact pairs and between all contact pairs and other metal parts
Temperature Range	-25 to +70 °C (-13 to +158°F), storage -25 to +55°C (-13 to +131°F), operation
UL94 Flammability Class	V-0
Enclosure Protection	IP20 without cover IP50 with dust cover attached

FTL Test Blocks have been classified as electromagnetically benign and are therefore excluded from the scope of the European Community Directive 2004/108/EC.

FTL meets or exceeds all requirements from ANSI / IEEE C37.90-2005.

### Mechanical

# of poles	8	10	12	14	16	18	20
Weight (kg)	1.04	1.25	1.46	1.67	1.88	2.09	2.30
(lbs)	2.29	2.76	3.22	3.22	4.14	4.61	5.07

## Dimensional Drawings

### 8-pole Models

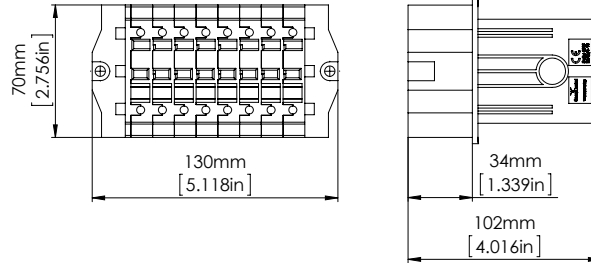

### 10-pole Models

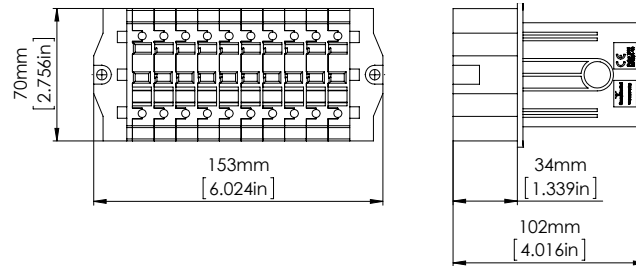

### 12-pole Models

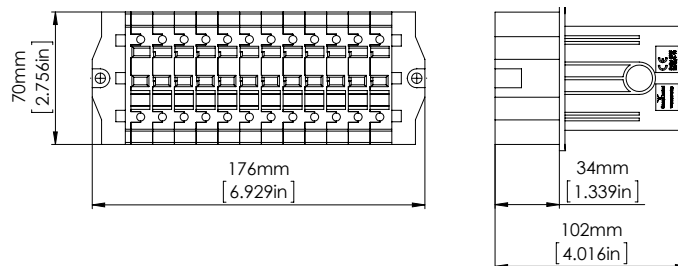

**14-pole Models**

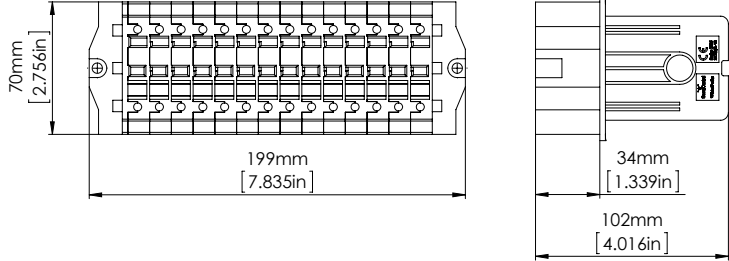

**16-pole Models**

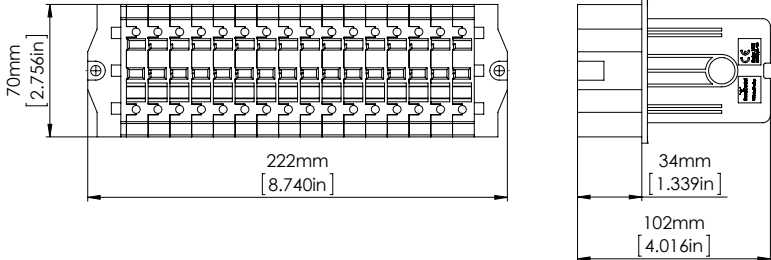

**18-pole Models**

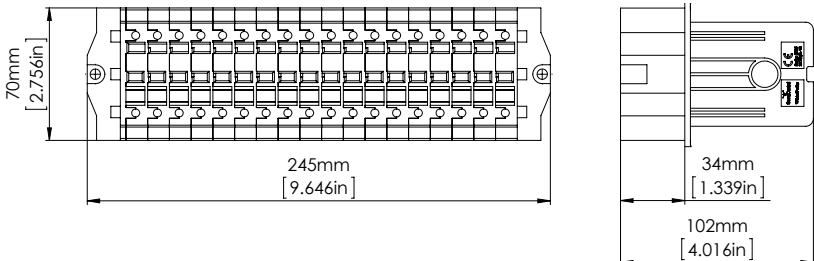

## 6. TECHNICAL SPECIFICATIONS

---

### 20-pole Models

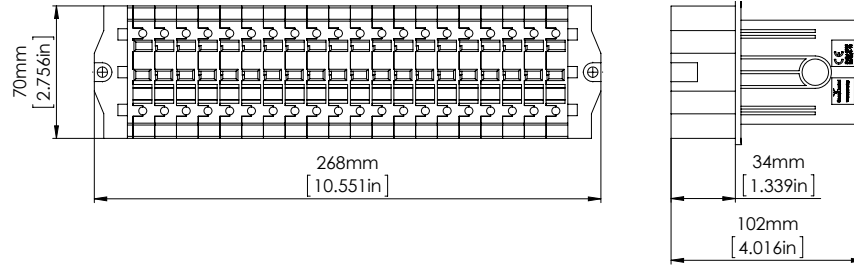

## 7 Models Available

### Number of banana jacks

The FTL test block typically comes with banana jacks both on the system side (side A) and on the device side (side B). The banana jacks on the B side constitute an essential component of the test bock. The banana jacks on the A-side are optional. Hence, two FTL models are available with and without the latter banana jacks:

<b>Model</b>	<b>Description</b>
FTL plus <sup>a</sup>	banana jacks on sides A & B
FTL light	banana jacks on side B

<sup>a</sup>regular version



# 8 Accessories

## Adapters for use with Insulated Banana Plugs

Allows the connection of test equipment with insulated banana plugs to the FTL test block (width of the insulated banana plug less than 11.5 mm)

Description	Order Code
Adapter for insulated banana plugs	FTIAR



## Adapters for use with Wide Test Leads

This adapter is built for the connection of test equipment with relatively wide insulated banana plugs (width of 11.5 mm or more) to the FTL test block. One side of the adapter connects to the wide test lead and then connects via a short cable to a smaller banana plug that fits comfortably into the FTL banana jacks. The banana plug in the adapter assembly has a see-through plastic shielding that recedes when entered into the FTL banana jack.

Standard color: red (red = RD in the last 2 digits of the Order Code)

Other Colors: ● RD ● BK ● BL ● YE ● GN ● VI

Description	Order Code
Adapter for wide test leads	FTIAW-RD



## Jumper Cable

This jumper cable allows the connection between 2 poles of the FTL test block. Both banana plugs of the jumper cable have a see-through plastic shielding that recedes

## 8. ACCESSORIES

---

when entered into the FTL banana jack.



The adapter isn't necessary for shorting the current transformer circuits. The current transformer circuits will be shorted automatically by the internal shorting of the FTL test block.

Standard color: red (red = RD in the last 2 digits of the Order Code)

Other Colors:



Description	Order Code
Jumper cable for use with the FTL	FTJUM-RD

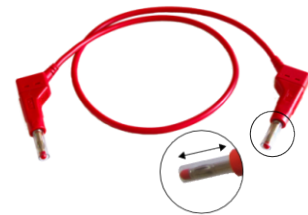

### Current Measurement Probe

This special test probe allows for the connection of a current measurement device or a shunt. The AWG 13 (2.5 mm<sup>2</sup>) connection cable has a length of 118 inches (3 meters). The test probe is available with c-hook terminals or banana plugs.

The current measurement probe is a special tool that is built for current measurement purposes. It does NOT automatically short-circuit current transformer circuits upon insertion into the FTL test block. Instead, current circuits are opened and redirected via the attached wires once the probe is entered into the test block. The probe must always be correctly connected to a measurement instrument or a shunt before insertion into the FTL test block, to prevent the creation of an open current transformer circuit. The current measurement probe should be used by properly trained personnel only.



Description	Order Code
C-hook connection	UTPC1
Banana plug connection	UTPC2



### FTL 19" Rack Plates

**SECUCONTROL** offers metal plates for installation of FTL test blocks in 19" racks that come painted in various colors and with various cutouts for FTL test blocks, in standard heights of 2U or 3U. Please contact **SECUCONTROL** if you require drawings or special customizations. The picture below shows an ANSI-grey #61 rack plate with three cutouts for 10-pole FTL test blocks.





- height**    Rack plates are available in 2U and 3U
- config.**    A: standard 19" rack plates, 2mm thick with standard cutouts  
 B-Z: reserved for special configurations
- cutout**    e.g.14x16 ζ cutout for one 14-pole (left) and one 16-pole (right) FTL test block  
 e.g.14xxxx ζ cutout for one 14-pole (left) FTL test block  
 e.g.xxxx18 ζ cutout for one 18-pole (right) FTL test block  
 e.g.100810 ζ cutout for one 10-pole (right), one 8-pole (middle) and one 10-pole (right) FTL test block  
 max. modules per rack plate = 30
- color**      These two digits define rack plate colors. Available options can be found in the table below:

Color	Description
AG	ANSI-grey #61
PG	pebble grey RAL 7032
LG	light grey RAL 7035
BK	black

For all configurations with 3 cutouts and 30 modules (e.g. 3 x 10-pole cutouts), **SECUCONTROL** recommends special FTL fitting screws (M5x22). These screws should be mounted on the far left and the far right side of the rack plate, to prevent the tip of the screws from touching the mounting frame. Two special screws are included with every FTL rack plate with 3 cutouts\30 modules. Please use the order codes below for reordering.



**Special FTL Fitting Screws**

Fitting set to fix the FTL test block in the rack plate cutout with 3 cutouts and 30 modules. The screw set contains two M5x22 hexagon socket head cap screws (4 mm)

## 8. ACCESSORIES

---

Description	Order Code
Special fitting set M5	SCPFT



### Covers for 19" FTL Rack Plate Cutouts

Built to cover existing cutouts in rack plates for FTL test blocks, these metal covers are offered for different FTL cutout sizes.

Description	Order Code ANSI-grey #61	Order Code light grey	Order Code pebble grey	Order Code black
8-pole cover	FTBC08AG	FTBC08LG	FTBC08PG	FTBC08BK
10-pole cover	FTBC10AG	FTBC10LG	FTBC10PG	FTBC10BK
12-pole cover	FTBC12AG	FTBC12LG	FTBC12PG	FTBC12BK
14-pole cover	FTBC14AG	FTBC14LG	FTBC14PG	FTBC14BK
16-pole cover	FTBC16AG	FTBC16LG	FTBC16PG	FTBC16BK
18-pole cover	FTBC18AG	FTBC18LG	FTBC18PG	FTBC18BK
20-pole cover	FTBC20AG	FTBC20LG	FTBC20PG	FTBC20BK

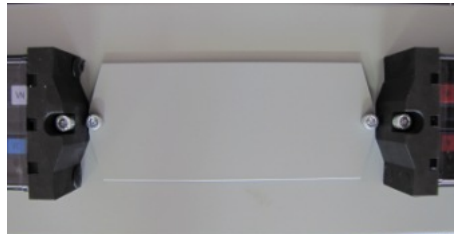

## 9 Spare Parts

### Disconnect Pins

# of poles	Labeling	Order Code
1	V	FTDP01RV
1	P	FTDP01RP
1	T	FTDP01RT
1	S	FTDP01RS
2	C- -C	FTDP02WC
4	C- -C- -C- -C	FTDP04WC

### Dust Covers

# of poles	Order Code
8	FTDC08
10	FTDC10
12	FTDC12
14	FTDC14
16	FTDC16
18	FTDC18
20	FTDC20



### Fitting Set

Fitting set to fix the FTL Test Block in the panel cutout. The screw set contains two M5x30 hexagon socket head cap screws (4 mm) and two M5 nuts.

Description	Order Code
Fitting set M5	SCSFT





# 10 Ordering Information

## Part Numbers

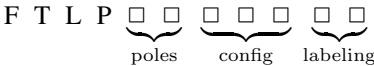

## Available Configurations

A list of available Configurations can be found in the download section of our website.

Should your application require a configuration that is not listed below, please contact **SECUCONTROL** at any of the addresses listed on the rear cover of this manual, or use the configurator on our homepage.





---

**North America**

SecuControl Inc.  
2873 Duke Street  
Alexandria, VA 22314  
USA  
Tel +1 703 838 7677  
mail@secucontrol.com  
www.secucontrol.com

**Europe**

SecuControl GmbH  
Ascherslebener Str. 3  
D-06333 Hettstedt  
Germany  
Tel +49 3476 550 022  
info@secucontrol.com  
www.secucontrol.com

**South America**

SecuBrasil Ltda  
Rod José Carlos Daux, 8600  
88050-001 Florianópolis SC  
Brazil  
Tel +55 (48) 3371 1670  
comercial@secubrasil.com  
www.secubrasil.com