

Interface Systems for Secondary Injection Testing

Simple, safe and economical connecting systems for test sets and protective relays

Presented to the International ETG Conference, Technical University of Dresden, Germany,
September 15, 2005

Dipl. Ing. Hubert Ostmeier
Secucontrol Inc.
2873 Duke Street
Alexandria, VA 22314
Phone: 703.838.7677
Fax: 703.838.1661
info@secucontrol.com
www.secucontrol.com

Introduction



Image 1: Protective Relay, Test Block and Test Plug with a Test Set

We use protective relays in medium and high voltage transmission grids. The electrical capacities monitored by the protective relay are produced by current and voltage transformers. Based on this data, the relay will initiate a breaker to interrupt the circuit in case of short circuits due to electrical faults in the grid, provided that defined tolerances are violated. Protective relays need to be tested for their proper function and setting before the initial operation of a substation. Subsequent periodic testing of protective relays is strongly recommended.

Test sets provide the necessary input, both in current and in voltage, in initial testing and in routine maintenance testing. The relay is exposed to manipulated input and can be tested according to its settings.

- Measurement of the development of the excitation curve

- Measurement of signal output time

- Testing of directional elements

- Cross checking of the relay signal, the signals received at short range and long range control centers

Device Types for Connecting Test Sets to Protective Relays

Rotary selector switches



Image 2: Siemens rotary selector switch



Image 3: Mauell rotary selector switch

Current terminals

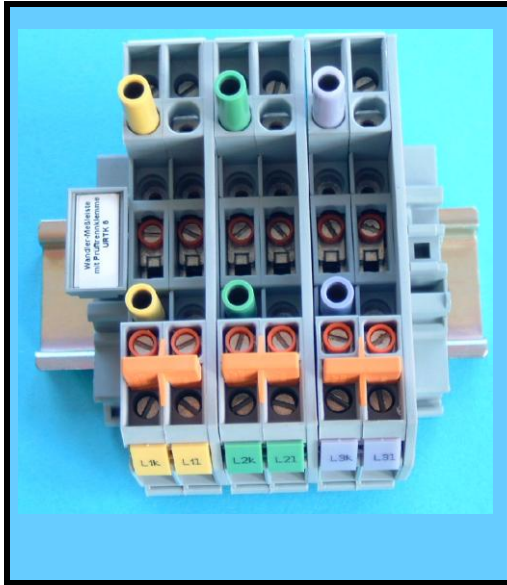

Image 4: Current terminals

Block & plug interface systems



Image 5: SecuControl, Areva and ABB interface systems

Knife blade test switches

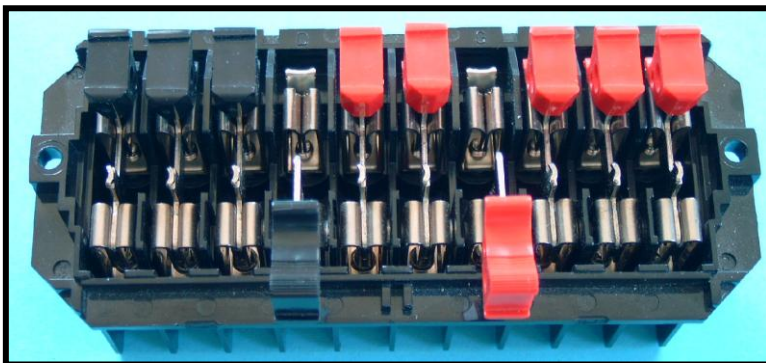

Image 6: Knife blade test switch (ABB, GE, Megger)

All of these devices have been in use for several years and bear their individual advantages and disadvantages.

A Comparison of Device Types

Before German unification, East Germany had been using a unified interface system consisting of a test block and a test plug. After German unification, the local utilities decided to further develop their unified standard. The result of this effort can be seen in the VDE standard published by the work group on interfaces in protective relay settings in April 2004.



Image 7: SecuControl interface test system

To further develop the standard, the task in 1996 was to establish an overview of international best practices. The assessment leads to the identification of strong regional differences:

- West Germany mainly uses rotary selector switches and current terminals
- The Anglo-Saxon world, Scandinavia and East Germany prefer test block and plug systems
- North America has its own test switch

An unfortunate result of this regional differentiation is that the systems are not compatible. The regional limitations of separate systems have obstructed technical advancements. But the economic disadvantages of the separation of the world in different product categories would be subject of a separate paper.

Looking at all product categories, an advanced device would contain the following technical features and functions:

- Global reach and coverage of all regional technical requirements
- The highest possible operational and material safety
- Simplicity in usage (e.g. replacement of existing systems without violation of existing technical specifications)
- A modular setup

A product size that corresponds to the function in testing and in the panel
Openness to long term technical developments
Long-term economical advantages for mass production

An exhaustive comparison of the technical features of the different product categories would stretch the limits of this introduction. However, an introduction of the main features can be a valid starting point for a discussion.

Rotary selector switches

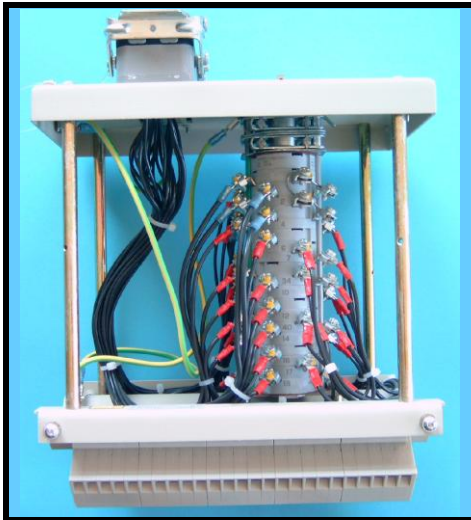

Image 8: Interior view of a rotary selector switch

Advantage: high level of safety

Disadvantage: bulky, needs a lot of space, a very expensive solution

The devices can be identified as a positively-driven rotary selector switch. No future technical innovation is to be expected in this product category.

Current terminals

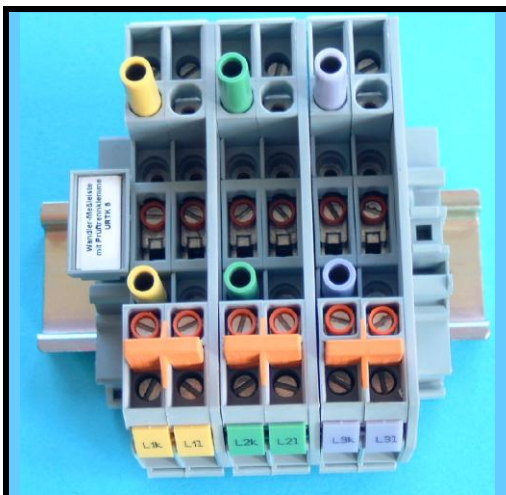

Image 9: Current terminal

Advantage: Low cost in building the cabinet. However, the low cost hardware asks for more handling and maintenance time. The cost advantage is soon turned into a maintenance cost disadvantage.

Disadvantage: a multitude of sources for mistakes, inferior protection of the CT circuits.

Secondary injection testing is not possible without further manipulation of the terminals. After each usage, the panel has to be tested to isolation. No future technical innovation is to be expected in this product category.

Knife blade test switches



Image 10: Knife blade test switches used in North America

The knife blade test switch was invented more than 60 years ago. The main manufacturers of this style test switch are ABB, Megger and GE.

Block & plug interface systems

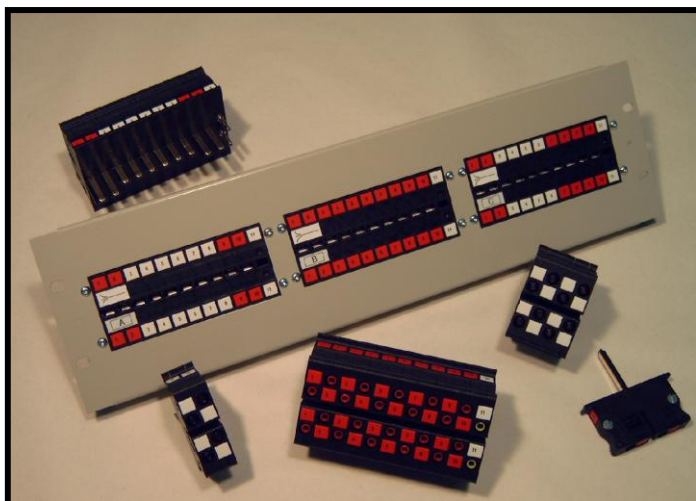

Image 11: SecuControl ITS test blocks & test plugs

The main manufacturers of interface systems are ABB, Areva and Secucontrol. Interface systems are best adapted to the needs of relay testing. A close look at the different systems unveils significant differences in safety and potential for technical innovation. These differences will be identified through a close look at Secucontrol's system and the diversions from it. The product category has not seen any innovation in the last 15 years except for the innovations in the Secucontrol product. A main reason for this could be the fact that Secucontrol is the only manufacturer who does not offer a corresponding relay line, all other systems have been developed as an accessory to a relay line. Therefore Secucontrol is the only manufacturer that can afford an independent vision of the product category.

How it works

To achieve a fast and safe connection of the test set, interface systems consist of a test block and a test plug. The test block is built into the protection control panel or the low voltage section of the breaker cell. The test block is an integral part of the relay/breaker circuit. This means that the test block matches the life span of the complete protection scheme, which is regularly more than 30 years.



Image 12: SecuControl, Areva and ABB interface systems

This mandates the following requirements for the test block:

The physical components of the test block have to match the high life-span of over 30 years in quality

The design of the test block should be as simple as possible with the focus on exclusively one function: opening the circuit without interruption and connection of the test set to the relay

New developments: the keyed interface system

In a global perspective, interface systems consisting of test block/plug solutions are showing the highest proportion of usage compared to other solutions.

A comparison of the interior mechanics of these systems shows the following:

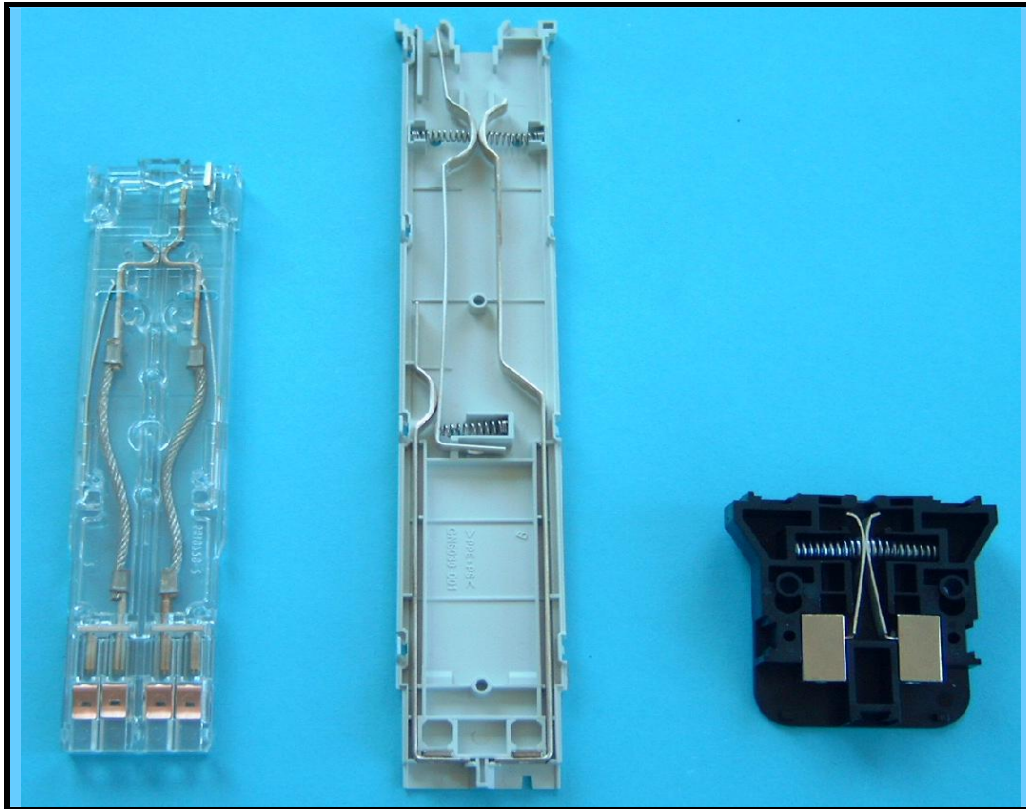

Image 13: interior mechanics of various test blocks: ABB, Areva, Secucontrol

The Secucontrol test block module demonstrates the most simplified design. Future innovations should always focus on the test plug. The test plug is associated with the test set and can be easily replaced. The claims we have established so far in this paper make it imperative, that the panel material should be made accessible for innovation in testing procedures.

Both the Areva and the ABB-Combiflex block modules have to provide additional moving points and pressurized contacts, because these systems work with very simple plug technology. Both systems are based on only one length of plug pins.

To achieve a differentiation in time between the opening of the trip circuits as compared to the opening of the current circuits, these systems have to differentiate the block modules at different depths inside the test block. At the same time, short circuiting of currents is facilitated between the block modules. This leads to a highly complicated design of the test block and increases the risk both of material failure and faulty usage. In addition, both Areva and ABB call for a special connection technology due to the size of modules and the complete test block, that is non-standard and costly.

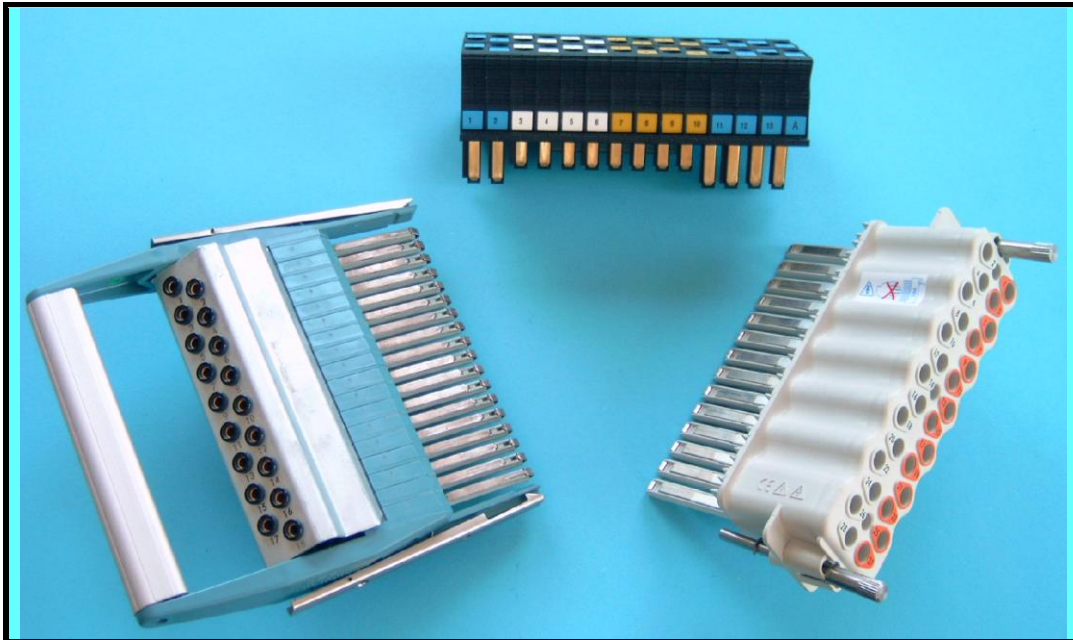

Image 14: Test plugs (ABB Combiflex, Secucontrol, Areva)

The Secucontrol test plug is assembled out of modules, so the plug may contain any number of modules between 2 and 21. ABB-Combiflex only provides plugs with 18 or 24 units. The Areva plug is generally limited to 14 units. Both ABB and Areva do not follow a modular approach.

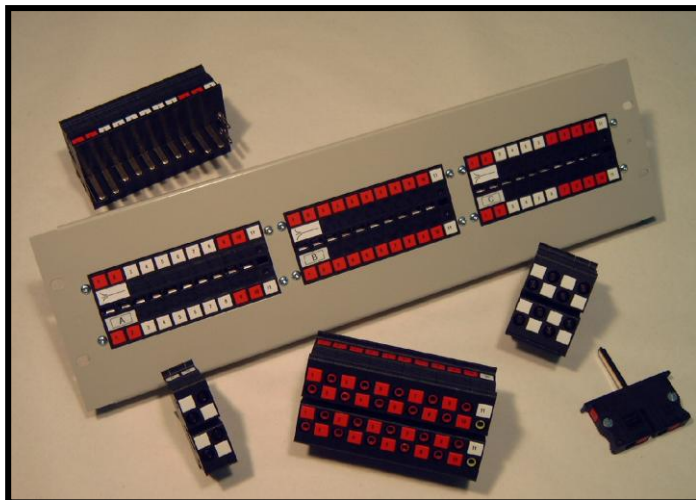

Image 15: Modular test blocks and test plugs

The simple design of the Secucontrol module achieves a very low internal resistance of less than 2mΩ through a defined contact point between two silver-coated copper contacts.

Test Plugs

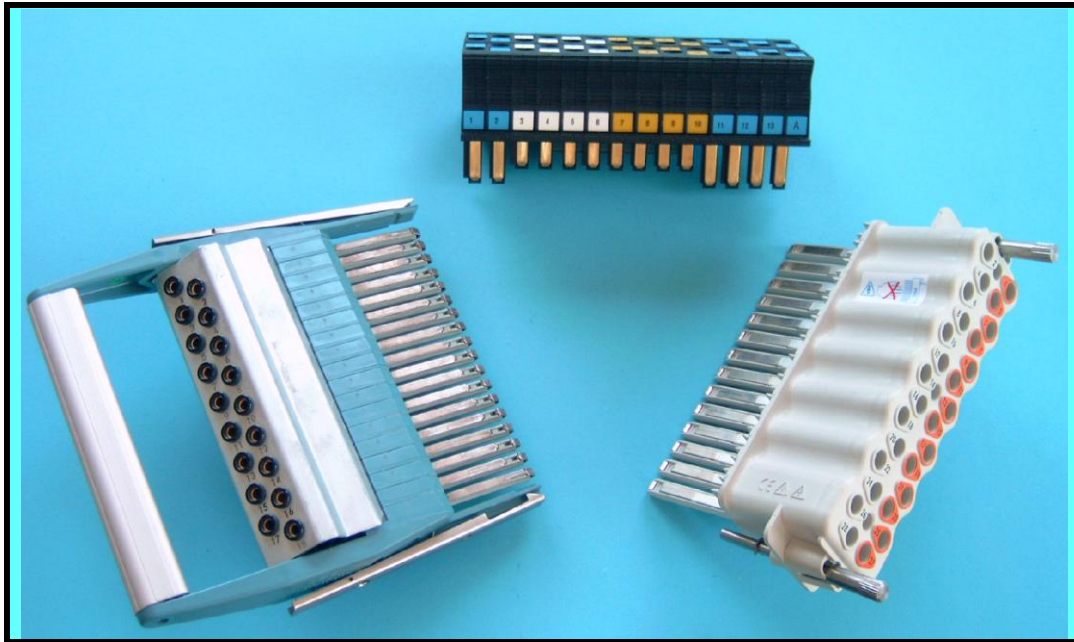

Image 16: ABB, Areva, Secucontrol

Out of these three test plugs, only the Secucontrol plug follows a modular design. The plugs of both Areva and ABB – Combiflex are assembled into predefined plastic cases. The modules of the Secucontrol plug are cases in themselves, containing two brass pins of equal length, separated from each other by an isolating plastic part. This plastic part reaches to the tip of the pin, so that the end of the pin consists of three layers brass/plastic/brass. This differentiates the Secucontrol plug significantly from both Areva and ABB – Combiflex, because the design of the pin reduces the risk of reversing currents. The brass contacts are connected inside of the Secucontrol case to double-isolated banana jacks.

The plug contains assigned shorting bridges for currents that have been assigned to contact points. The pins of the test plug are available at different lengths, which provides for a sequenced opening of contacts. The pins are isolated on the inside between two sheets of brass by a layer of plastic, separating the system side from the relay side. The pins of the test plug are coded and can only be inserted into the assigned opening of the test block. Mistakes by insertion of a wrong complex plug or wrong individual probes are eliminated through the coding. More on the coding system in a later in this paper.

Function and sequence during the insertion of the plug

Secucontrol – How it works

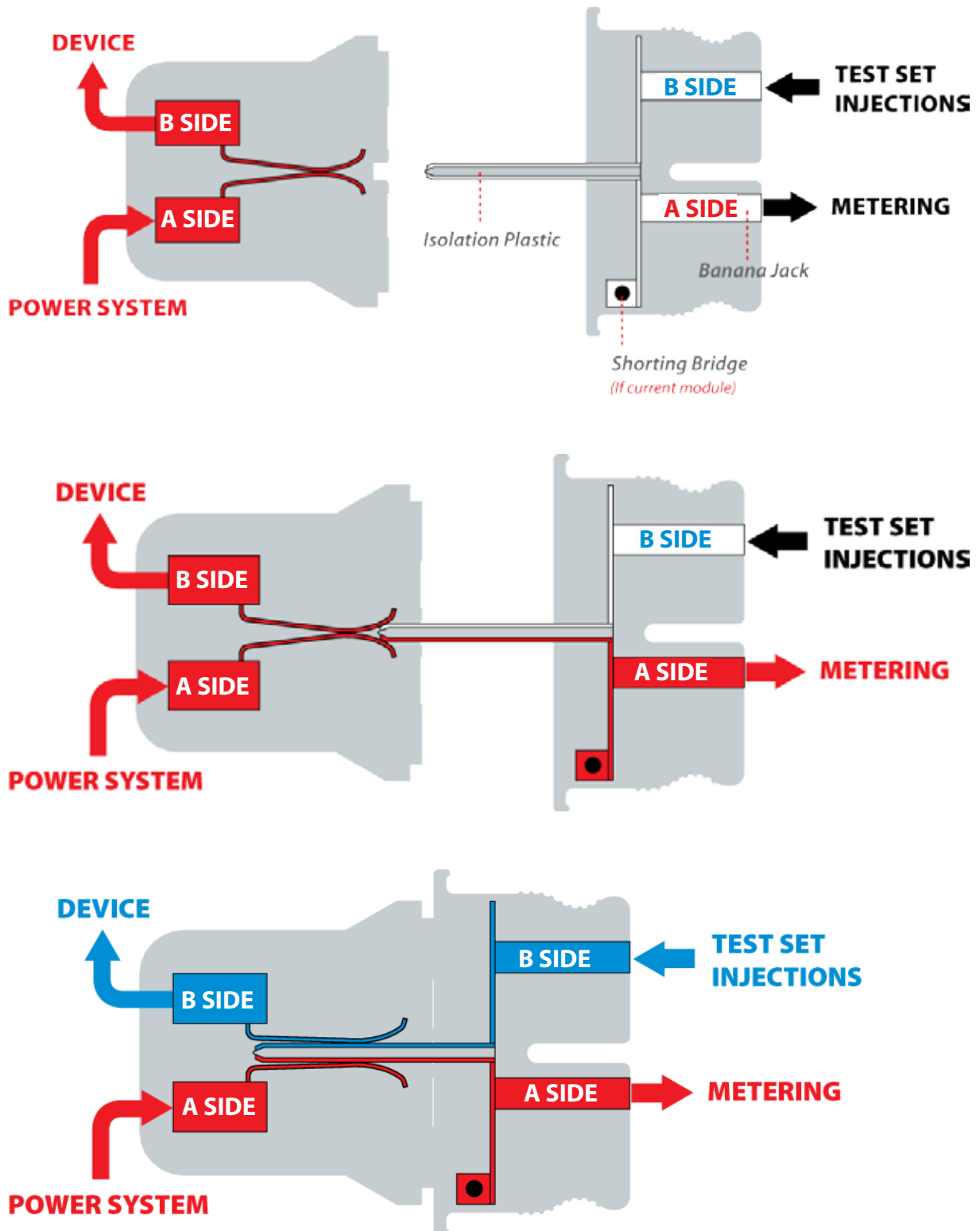

Areva – How it works

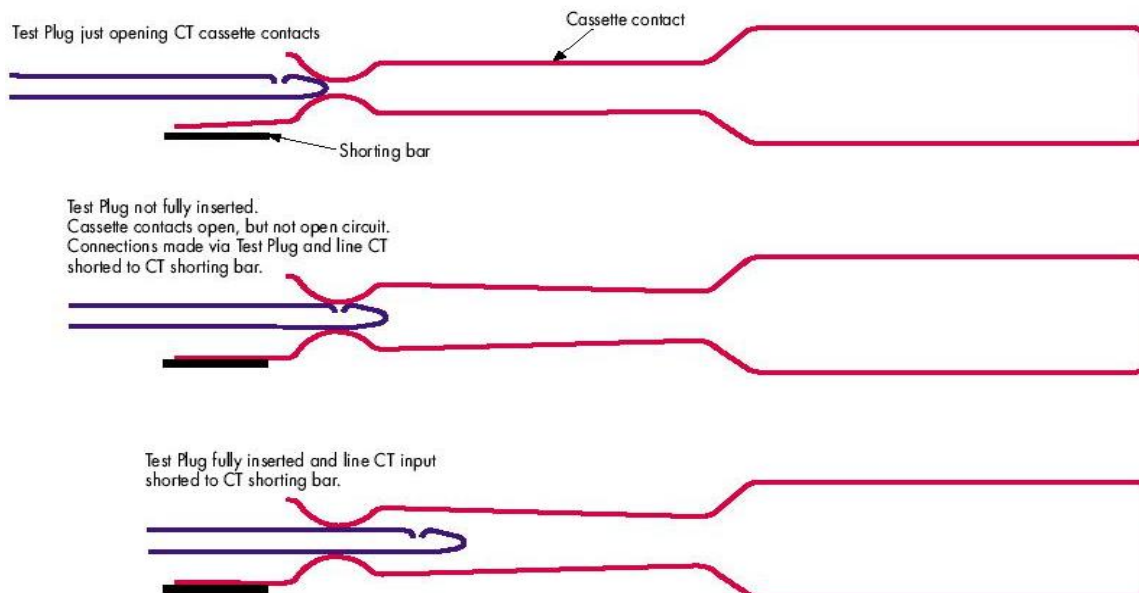

1. P992 insertion of multi-fingered test plug causes line CTs to be shorted together ie. non-hazardous.
2. P993 insertion of single-fingered test plug causes only one test block CT contact to connect with the shorting bar, therefore line CT is not shorted. This enables measurement of current via the P993.
The P993 always ensures a load is connected across the CT circuit.

Image 18: Areva schematic functions (source: Areva Micom user manual)

Secucontrol achieves the shorting of currents through a fixed shunting bar on the inside of the plug. In the Areva/ABB systems, the pin of the plug pushes a metal sheet on the inside of the block against a shunting bar on the inside of the block, thus establishing a shorting of current. This means that continuously the current circuit is exposed to two movable points in the Areva/ABB systems, while the Secucontrol system provides a single movable point secured by springs exerting continuous pressure. In addition, the Areva/ABB system can lead to reversing currents if a pole of the block is used for the injection of DC current. The Secucontrol design of the pin tip eliminates this danger successfully.

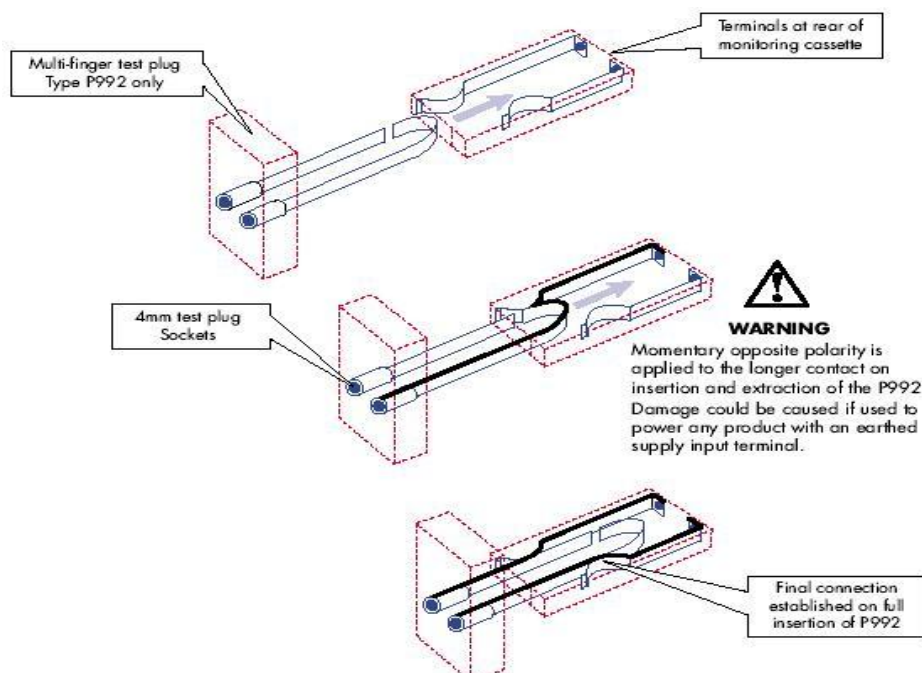

Image 19: Consequences of the different designs (source: Areva Micom user manual)

Automated Sequence of Opening

The design of the Secucontrol test plug prescribes up to 4 steps in the sequence of opening contacts:

Step 1: The long pins open assigned trip circuits.

Step 2: A second length of pins opens an assigned second group of trip circuits

Step 3: Short pins open currents and voltages

Step 4: Current circuits are shorted by shorting bars in the plug. The relay is now ready for secondary injection testing.

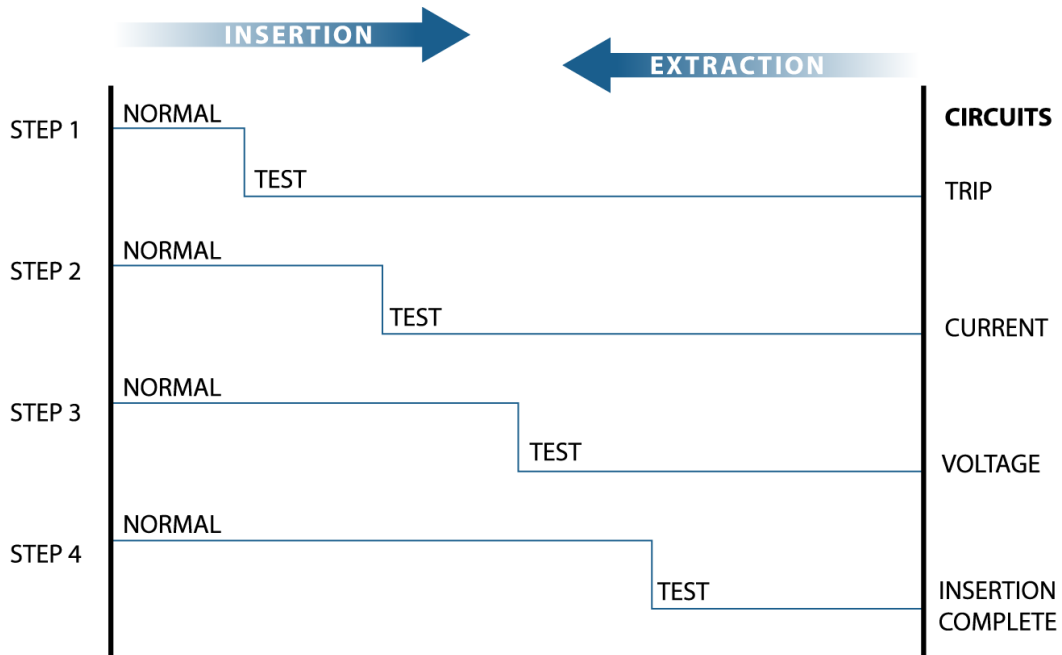

Automatic Operating Sequence using SecuControl ITS TestPlug

Image 20: Sequence in time during insertion and extrusion

The Secucontrol system allows for a sequence in the isolation of different kinds of trip circuits.

Safety Aspects – The Coding System

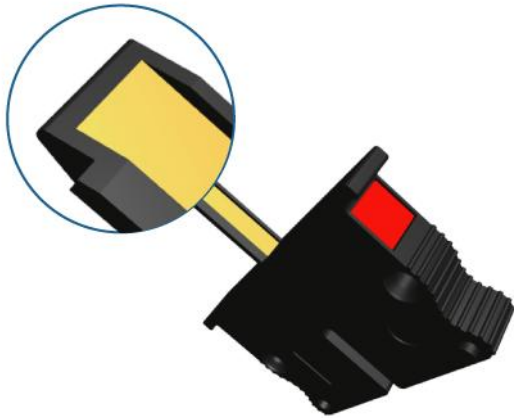

Image 21: The coding system (Secucontrol)

The Secucontrol ITS is the only fully modular system that also provides a coding system of the individual pole. This coding system has been filed for patent protection. The coding is achieved by a differentiation in shape of the isolating sheet of plastic between the brass units of the plug pin. The corresponding opening of the block module has to match this shape. The coding system eliminates the wrongful insertion of complex plugs and individual probes that are not assigned to the openings. The coding systems also defines that only shorted pins can be inserted into current circuits.

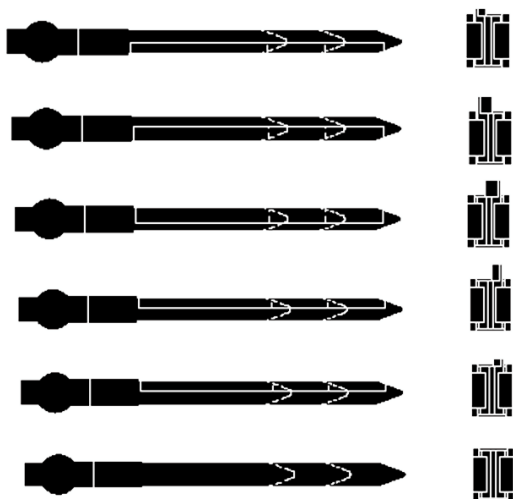

Image 22: Design of the coding system (Secucontrol)

The coding system is a valuable tool in the establishment of standard test routines and their corresponding designs into the test blocks and plugs. The modular setup allows for customer specific designs of complex blocks and plugs, which can be repeated on similar settings within the customer's systems. These designs provide for a maximum of safety and economy in the testing of relays. Other systems do not match this flexibility.

Additional material to the Secucontrol ITS system

The compact design and the modularity of the ITS present a clear advantage for economies of space in the panel. The individual modules are additionally usable for other functions. If the case holds a bridge instead of the copper contacts, the module can function as a normal connector in the assembly of opening points.

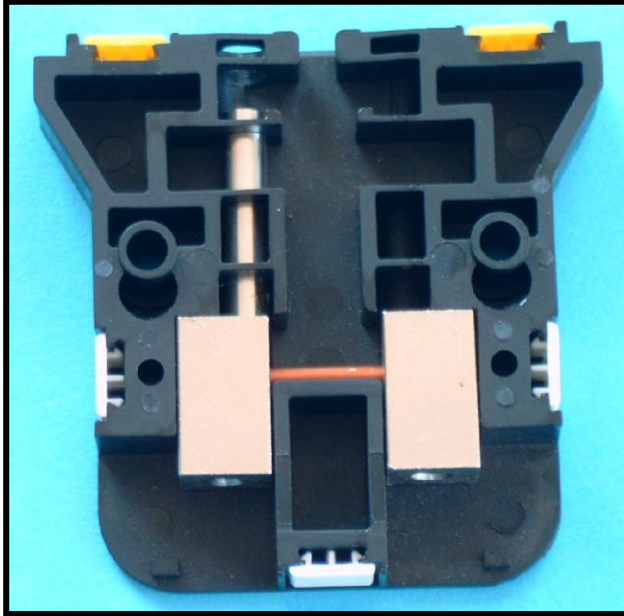

Image 23: Module of the ITS containing a bridge as a connector for measurement

If the module is equipped with two additional banana jacks, the function for a closing contact is established.

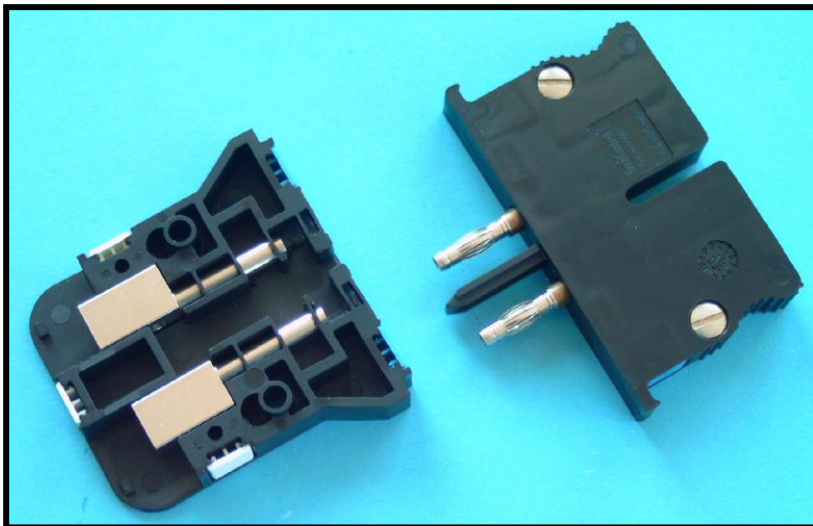

Image 24: Module of the ITS as a closing contact

This closing function can serve to transmit a signal to headquarters that a test device has been inserted and the relay is temporarily not operational. Further variations of the module are currently being designed.

Conclusion

To establish a quick and safe connection between the relay and the test set, any material establishing this connection needs to meet the following requirements:

The basic function: The act of opening and connecting needs to remain close to the relay by use of a test block

All other functions should be performed by the test plug: The principle should be to keep the test block as simple as possible and incorporate complex functions and innovations in the test plug. An example of future developments: integration of test plug and test set.

A system of this kind needs to be usable globally.

A system of this kind needs to be independent from a manufacturer's relay line to provide the widest possible range of usage.

The system should be modular.

The system should conform to the highest safety standards and exclude human error through a keying system.

The system should reduce testing time and operational cost to a minimum.

The Secucontrol ITS has incorporated these demands into its current design.

Literature

ABB, Flexitest Switch, Type FT-1 und FT-1X, Descriptive Bulletin 41-077, effective date February 2004

Alstom T&D Protection & Control, Micom P990 Series Test Block and Test Plugs, Produkthandbuch Stand 2002

Doemeland, Wolfgang, Handbuch Schutztechnik, Grundlagen – Schutzsysteme – Inbetriebsetzung, Berlin/Offenbach 2003

Kretschmar, G.; Hauschild, J.; Krös, W.; Wolf, R.; Schossig, W., Richtlinie Prüfsteckvorrichtungen für Schutzeinrichtungen, VDE Bezirksverein Dresden, AK „Relais- und Schutztechnik“, AG „Hochspannungs-“ und „Mittelspannungstechnik“ Dresden: 2002 und aktualisierte Ausgabe 3/2004

Müller, H. u.a., Anschaltung von Prüfsteckvorrichtungen 19-, 14- und 7-polig an Schutzrelais, Bericht-Nr. 74-1215 [1976] BE, IEV Dresden vom 03.09.1975

Müller, H. u.a., Der Anschluß von Prüfsteckvorrichtungen für Schutzrelais und Schutzrelaiskombinationen, Bericht-Nr. 74-2498-(1985) FE. IEV Dresden vom 30.03.1985. Ergänzung: Einsatz von Prüfsteckdosen für digitale Schutzrelais. TEAG Thüringer Energie AG, Erfurt, 11.07.1994

Prüfempfehlungen für digitale Schutzeinrichtungen mit Selbstüberwachung, Stand April 1995, Frankfurt/M VDEW-AA „Relais- und Schutztechnik“

Schossig, Walter, Einsatz von Prüfsteckdosen für Netzschutzeinrichtungen, etz Elektrotechnik und Automation 11-12/2002, S. 38-40

Siemens, Schaltanlagen für die Mittelspannung vom Kompetenzzentrum Frankfurt – Treffen Sie die richtige Entscheidung für Ihr Netz, Produktbroschüre Bestell Nr.: E50001-U229-A201