

# SAX / STP Test Blocks & Plugs (4600 Series)

## Reference Handbook

sax-reference-en 24:7bf1ce514787



## **Copyright Notice**

All information provided in this document is the property of **SECUCONTROL** .

**SECUCONTROL** grants its customers or potential customers the right to download, copy, store and print this document for the sole purpose of assisting them in the correct application of the products mentioned in this document.

All other uses of this document are expressly prohibited.

## **Intellectual Property Notice**

This publication contains proprietary information under protection of the following (among others) patents: DE 10 2005 025 108, DE 10 2008 016 388, US 7,271,357 and US 7,884,597.

## **Contents Disclaimer**

Although the information and recommendations in this document are presented in good faith and believed to be correct as of publication date, **SECUCONTROL** makes no representations as to the completeness or accuracy thereof. In no event shall **SECUCONTROL** be responsible for damages of any nature resulting from the use of or reliance upon the contents of this document.

## **Continuous Improvements**

Products developed by **SECUCONTROL** are continuously improved. The information in this document may, therefore, be out of date.

Please make sure you have the latest release of this document before proceeding by checking its name and revision code. This information is printed on the front cover of this document, underneath the title. The latest release of this document can be downloaded from [www.secucontrol.com/downloads](http://www.secucontrol.com/downloads). Alternatively, you may contact **SECUCONTROL** at any of the addresses provided on the rear cover of this document.

# Contents

<b>1</b>	<b>Introduction</b>	<b>1</b>
	The SAX / STP Terminal / Test Block & Plug (4600 Series) . . . . .	1
	Key Features . . . . .	1
	Applicable Models . . . . .	1
	Unpacking . . . . .	2
	Part Number and Manufacturing Date Location . . . . .	2
	Safety Symbols . . . . .	3
	General Safety Instructions . . . . .	3
<b>2</b>	<b>Application</b>	<b>5</b>
	Schematic Symbols . . . . .	5
	Typical Connection Schematic . . . . .	6
<b>3</b>	<b>Installation</b>	<b>7</b>
	Terminal / Test Block Dimensions, Drill Scheme and Mounting . . . . .	7
	Wiring . . . . .	9
<b>4</b>	<b>Operation</b>	<b>13</b>
<b>5</b>	<b>Technical Specifications</b>	<b>15</b>
	Electrical . . . . .	15
	Mechanical . . . . .	16
	Dimensional Drawings . . . . .	16
<b>6</b>	<b>Accessories</b>	<b>19</b>
	Cases for STP Test Plugs . . . . .	19
	Individual Test Probes . . . . .	19
	Universal Test Probes Set . . . . .	20
	Handles for STP Test Plugs . . . . .	20
	Dust Covers for SAX Test Blocks . . . . .	20
<b>7</b>	<b>Spare Parts</b>	<b>21</b>
	Fitting Screws . . . . .	21
<b>8</b>	<b>Ordering Information</b>	<b>23</b>
	Part Numbers for SAX Terminal / Test Block (4600-Series) . . . . .	23
	Part Numbers for STP Test Plug(4600-Series) . . . . .	23
	Configuration Selection Chart . . . . .	24



# 1 Introduction

## The SAX / STP Terminal / Test Block & Plug (4600 Series)

SAX is a surface mount terminal / test block combination for interfacing substation devices (protection relays, fault recorders, revenue meters, ...) to the voltage and current transformers and to other equipment on the system side of a power grid.

STP is a Test Plug keyed to a particular configuration of SAX Blocks. Once inserted into the corresponding test block, the STP Test Plug isolates the substation devices from the system side equipment. Once the test plug is inserted the secondary injection can be performed.

## Key Features

- Terminal block and test block in one - reducing panel space and wiring time needs
- Finger-safe test block and test plug increase safety during testing
- Test plugs are keyed to the corresponding test blocks and help eliminate the most common human errors during testing - and their sometimes costly consequences
- Built-in automatic operating sequence prevents spurious breaker operation
- Extremely low internal resistance ( $< 2 \text{ m}\Omega$ ) helps reduce heat inside cabinets and panels and decreases the risk of saturation when using 1 A current transformers
- Available in 7, 10, 14 or 20 pole configurations
- Facilitates efficient, standardized testing procedures
- DIN rail mount or surface mount with screws
- Connection terminals fit ring cable and many crimp connectors

## Applicable Models

Information in this document applies to all SAX Terminal / Test Blocks and STP Test Plugs manufactured after February 2012.

### **Unpacking**

Unpack the product carefully and make sure that all pertinent parts like mounting screws (and dust covers, if included) are put aside so they will not be lost.

Check the contents against the packing list. If any of the contents listed are missing, please contact **SECUCONTROL** immediately (see contact information at the rear cover of this manual).

Examine the product for any shipping damage. If the product is damaged, notify the shipping company without delay. Only the consignee (the person or company receiving the unit) can file a claim against the carrier for shipping damage.

### **Part Number and Manufacturing Date Location**

Part number and manufacturing date are stated on a label on the right side of the Test Block or Test Plug.

## Safety Symbols

The following symbols are located on different parts of the equipment and in this manual:



Paragraphs marked with this symbol contain information which, if not properly followed, may cause damage to the equipment and/or installation.



Paragraphs marked with this symbol contain information which, if not properly followed, may cause personal injury or even death.

---

## General Safety Instructions

Installation and operation of the products described in this manual is only to be performed by personnel that has been trained or is knowledgeable in substation protection, automation and control.

This instruction manual is an integral part of the scope of delivery and provides basic instructions for installation and operation of the equipment here described. Shall additional information be needed, please contact **SECUCONTROL** at any of the addresses provided on the rear cover of this document.

Do not disassemble the test block or test plug. Correct alignment of internal parts is critical in order to provide insulation and arch-avoidance.



The warranty will be void if the test block or test plug is disassembled (or otherwise handled inappropriately). SecuControl does not assume responsibility for any damages arising out of mishandling of our products, including test blocks / test plugs that have been disassembled by parties other than SecuControl.







## 2 Application

### Schematic Symbols

Following symbols are suggested in order to represent the SAX Terminal / Test Block in schematic diagrams.

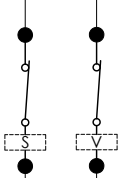
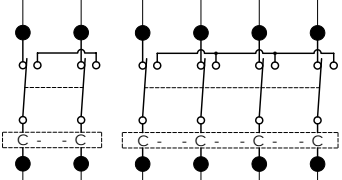
Symbol	Description
	Signal, Voltage (single pole)
	Current (2-pole, 4-pole)

### Typical Connection Schematic

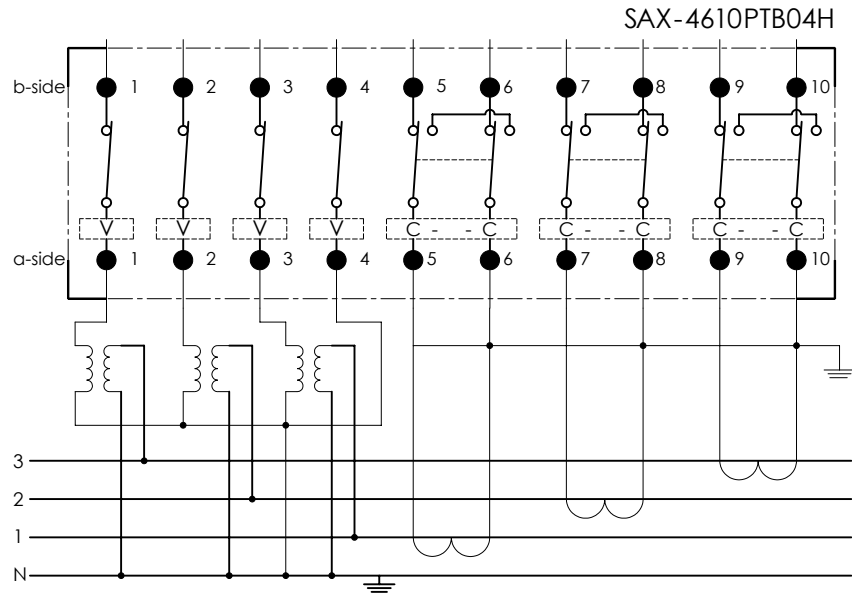

# 3 Installation

## Terminal / Test Block Dimensions, Drill Scheme and Mounting

The SAX Terminal / Test Block can either be mounted on DIN rail (35 mm, top hat rail), or with 4 screws (M4x50, provided when this option is chosen) onto a flat surface. The mounting option (DIN rail or screws) must be specified at the time of order.

The dimensions of the SAX Terminal / Test Block are shown in the following graphic:

### 7-pole Models

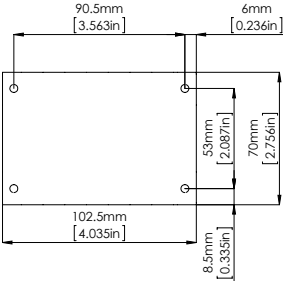

### 3. INSTALLATION

---

#### 10-pole Models

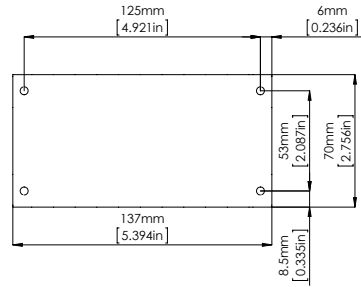

#### 14-pole Models

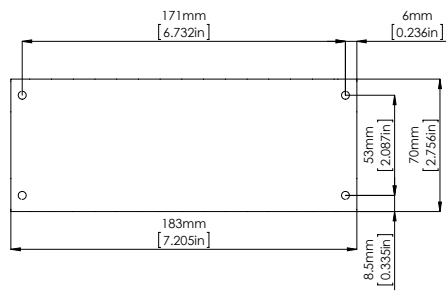

#### 20-pole Models

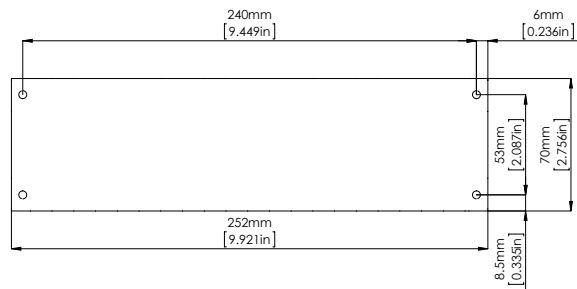

If the screw mount option is used the drill scheme shown below applies. Metric thread (M4) is required for the threaded holes.

## Wiring

Electrical connection terminals are located on the sides of the SAX Terminal / Test Block. The connection terminals combine a screw in the center with a pressure plate, accepting ring cable lugs, stripped wire or other crimp connectors. The terminal connection screws are captive, so they cannot be lost.

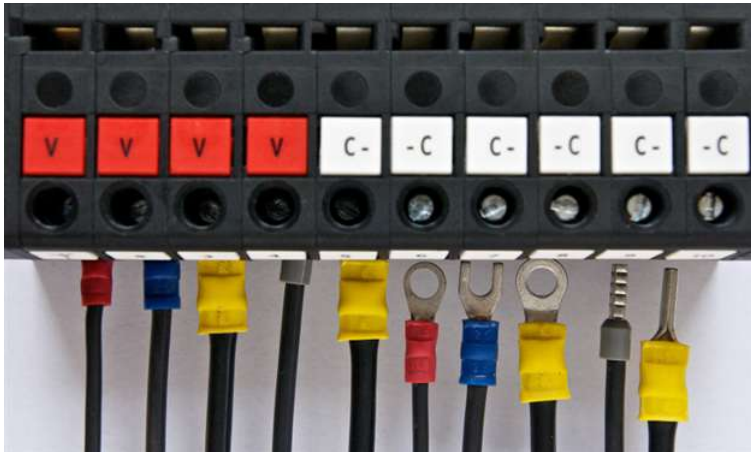

Recommended wire gauge is from 1,5 mm<sup>2</sup> (AWG 16) to 4 mm<sup>2</sup> (AWG 12).

CTs should be wired to the terminals provided for this purpose (in 2- or 4-pole combinations) to ensure automatic short circuiting upon insertion of STP Test Plugs or individual test probes into the SAX Terminal / Test Block. The terminals designated for the connection of the CTs can typically be identified by the 

C-	-C
----	----

 or 

C-	-C-	-C-	-C-
----	-----	-----	-----

 labeling<sup>1</sup>.

In addition to the one rows of labeling in the front, the SAX Terminal / Test Block has one row of labels each on the sides where the connection terminals are located. All "poles" (or test block modules) are continuously numbered (e.g. from 1 through 20 for a 20-pole SAX).

One label on each side of the SAX Terminal / Test Block indicates with the letter "a" or "b" if the connection terminals on that side are associated with the "A-SIDE" (system side), or "B-SIDE" (device side).

SAX functionality requires that the B-SIDE (device side) of the test block must be connected with the device to be tested (e.g. protective relay), and the A-SIDE (system side) must be connected to the electrical system (e.g. CTs, PTs and breakers).

Following graphics show the labeling in the front and on the sides of a typical SAX Terminal / Test Block.

<sup>1</sup>custom labeling may show other symbols or use other colors.





**14-pole Models**

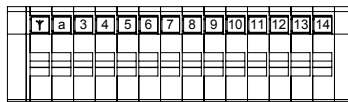
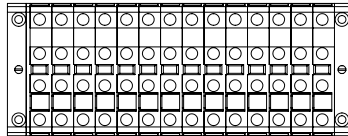
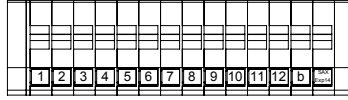

**20-pole Models**

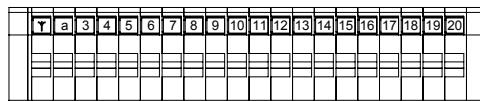
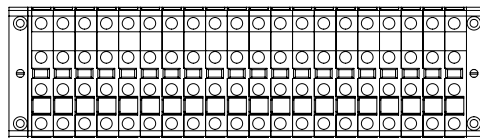
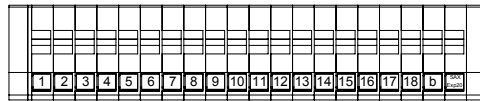





## 4 Operation

Handling of STP Test Plugs and test probes (smaller plugs for individual circuits) should be done using only the handle and/or insulated plastic parts, since the fingers may be connected to live equipment either via the test block or test equipment.



Store the STP Test Plugs and test probes carefully in order to avoid damage to the metallic test fingers. **SECUCONTROL** recommends using one of the cases listed under “Accessories” on page 19.



1. Remove the SAX dust cover (if one is used, optional accessory) by unscrewing the two knurled screws that hold it, and lifting it up.
2. Carefully align the STP Test Plug or test probe with the corresponding positions on the SAX Terminal / Test Block.
3. Insert the STP Test Plug or test probe in one smooth and even movement into the SAX Terminal / Test Block.

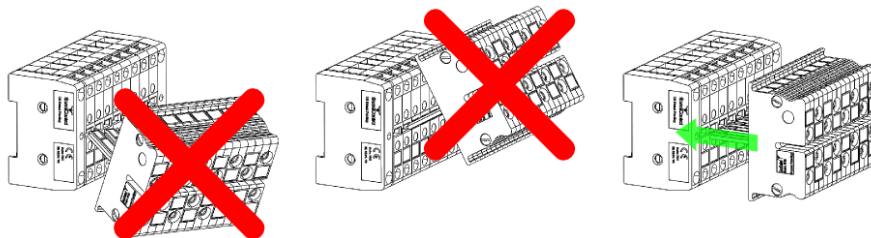

Even insertion means that the test plug should always be positioned in a line parallel to the terminal / test block while inserting - not at an angle.

There is no need to externally short-circuit the current transformers, since the STP Test Plugs and test probes have internal shorting bars which will automatically short circuit the corresponding circuits before opening them.

4. Connect cables from the test set with the corresponding STP Test Plug or test probe.  
For the purpose of injecting currents and voltages into the connected device (e.g. relay), the test set must be connected to the B-SIDE (device side) of the STP Test Plug or test probe. The connection of the test set to the test plug should be made after the plug has been inserted into the SAX Terminal / Test Block.
5. Once you are ready to resume normal operation, disconnect the cables from the STP Test Plug or test probe.



#### 4. OPERATION

---

6. Finally, remove the STP Test Plug or test probe in a single, even and continuous movement.
7. Reattach the dust cover (if one is used).

## 5 Technical Specifications

### Electrical

Current Withstand	30 A continuously 500 A for 1 second
Maximum voltage	600 V
Contact resistance	$\leq 2 \text{ m}\Omega$
Dielectric Withstand	3.0 kV RMS for 1 minute between adjacent contact pairs and between any contact pair and other metal parts 2.0 kV RMS for 1 minute between open contacts when test plug is inserted
Voltage Impulse	3 positive and 3 negative impulses of 5 kV peak, 1.2/50 $\mu\text{s}$ , 0.5 J between adjacent contact pairs and between all contact pairs and other metal parts
UL94 Flammability Class	V-0
Enclosure Protection	IP20 without cover

SAX / STP has been classified as electromagnetically benign by the Guide for the EMC Directive 2004/108/EC and is, therefore, excluded from the scope of the EMC Directive.

SAX / STP meet or exceed all requirements from ANSI / IEEE C37.90-2005.

## 5. TECHNICAL SPECIFICATIONS

### Mechanical

# of poles		7	10	14	20
SAX Weight	(kg)	0,49	0,67	0,91	1,26
	(lbs)	1,08	1,48	2,01	2,78
STP Weight (without Handle)	(kg)	0,33	0,46	0,65	0,93
	(lbs)	0,73	1,01	1,43	2,05
STP Weight (with Handle)	(kg)	0,54	0,69	0,90	1,21
	(lbs)	1,19	1,52	1,98	2,67
STP Weight (with fitting screws)	(kg)	0,57	0,73	0,94	1,25
	(lbs)	1,26	1,61	2,07	2,76

The above table shows typical standard sizes. Please contact **SECUCONTROL** for additional information regarding other pole lengths.

### Dimensional Drawings

#### 7-pole Models

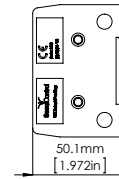
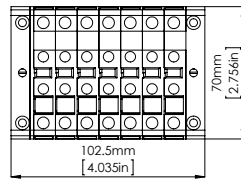

#### 10-pole Models

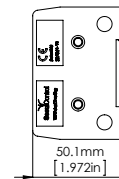
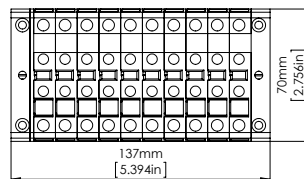

14-pole Models

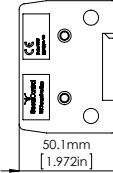
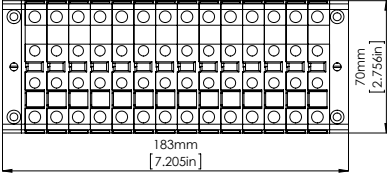

20-pole Models

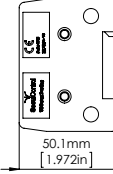
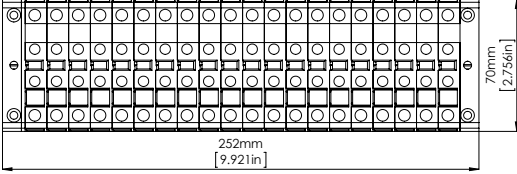



## 6 Accessories

### Cases for STP Test Plugs

Rugged case for STP Test Plugs and test probes.

Description	Order Code
Case for STP Test Plug	CSTP1



### Individual Test Probes

These test probes will fit all SAX Terminal / Test Blocks, regardless of configuration. Keying in the probes prevents insertion into wrong circuits (ie, 2-pole current probes can only be inserted into a 2-pole current part of a SAX Terminal / Test Block). Current probes include internal shorting bridge.

Description	Order Code
Single pole probe (voltage)	STP-4601PSP01H
Single pole probe (signal)	STP-4601PSP02H
Single pole probe (trip)	STP-4601PSP03H
2-pole probe (single current and return)	STP-4602PSP04H
3-pole probe (three voltages)	STP-4603PSP05H
4-pole probe (four voltages)	STP-4604PSP06H
4-pole probe (three currents, common return)	STP-4604PSP07H
6-pole probe (three currents and return)	STP-4606PSP08H

### Universal Test Probes Set

Set of individual test probes in a rugged case. Two configurations are available:

#### “Small” Set

- 3 × 2-pole current probes (for single currents and return)
- 1 × 4-pole current probes (for three currents and common return)
- 6 × single pole probes (for voltages, trips and signals)

#### “Large” Set

- 6 × 2-pole current probes (for single currents and return)
- 2 × 4-pole current probes (for three currents and common return)
- 12 × single pole probes (for voltages, trips and signals)

Description	Order Code
Universal Test Probe Set “Small”	USTP1
Universal Test Probe Set “Large”	USTP2

### Handles for STP Test Plugs

STP Test Plugs can be built with a handle, which helps with the easy and even insertion into the test block (in particular for test blocks with many poles).

The handle option needs to be specified upon test plug order - please compare the ordering information section of this document.

Three handle options are available:

- STP Test Plug with standard handle
- STP Test Plug with handle, with two fitting screws (M4) to affix the plug to the SAX Test Block during testing.

### Dust Covers for SAX Test Blocks

# of poles	Order Code See-Through Plastic	Order Code Metal, ANSI grey
7	SAXDC07ST	SAXDC07AG
10	SAXDC10ST	SAXDC10AG
14	SAXDC14ST	SAXDC14AG
20	SAXDC20ST	SAXDC20AG

Please contact **SECUCONTROL** for custom products that are not listed above.



## 7 Spare Parts

### Fitting Screws

M4x50 SAX screws (for surface mounting with screws)

Description	Order Code
M4x50 socket cap screw 10pcs.	SCR450





## 8 Ordering Information

### Part Numbers for SAX Terminal / Test Block (4600-Series)

<b>S A X 4 6</b>	<input type="checkbox"/>	<input type="checkbox"/>	<b>B</b>	<input type="checkbox"/>	<input type="checkbox"/>	<input type="checkbox"/>	<input type="checkbox"/>	<b>H</b>
7 pole	0	7						
10 pole	1	0						
14 pole	1	4						
20 pole	2	0						
DIN rail surface mount			D					
Surface mount (4x M4 Screws)			S					
Standard configurations			S	B				
Ten-pole configurations			T	B				
Additional configurations			A	B				
Configuration Number (1 to 27)						*	*	

### Part Numbers for STP Test Plug(4600-Series)

<b>S T P 4 6</b>	<input type="checkbox"/>	<input type="checkbox"/>	<input type="checkbox"/>	<input type="checkbox"/>	<input type="checkbox"/>	<input type="checkbox"/>	<input type="checkbox"/>	<b>H</b>
7 pole	0	7						
10 pole	1	0						
14 pole	1	4						
20 pole	2	0						
Without handle			P					
With handle			K					
With handle and fitting screws M4			L					
Standard configurations			S	B				
Ten-pole configurations			T	B				
Additional configurations			A	B				
Configuration Number (1 to 27)						*	*	

### Configuration Selection Chart

Common standard configurations available from **SECUCONTROL** are listed on the following pages.

Should your application require a configuration that is not listed below, please use our on-line configuration tool at [www.secucontrol.com](http://www.secucontrol.com). Alternatively, you may contact **SECUCONTROL** at any of the addresses listed on the rear cover of this manual.

Abbreviation	Description
CS	Current shorting bar is integrated in the probe.
LF	Long finger in the probe, this module opens first.

#### 7-pole Models

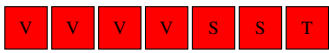
Config	Label	Description
SB 01 H		V V V V $\underbrace{T T T}_{LF}$
SB 01 H		

Config	Label	Description
AB 01 H		$\underbrace{T T T T T T T}_{LF}$
AB 01 H		

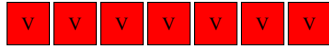
Config	Label	Description
AB 02 H		V V V V V V V
AB 02 H		

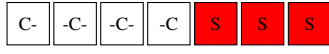
Config	Label	Description
AB 03 H		$\underbrace{C-C-C-C}_{CS} \underbrace{T T T}_{LF}$
AB 03 H		

Config	Label	Description							
AB 04 H		$\underbrace{C-C-C-C}_{CS} V V V$							
AB 04 H		<table border="1" style="display: inline-table; vertical-align: middle;"> <tr> <td>C-</td> <td>-C-</td> <td>-C-</td> <td>-C-</td> <td>V</td> <td>V</td> <td>V</td> </tr> </table>	C-	-C-	-C-	-C-	V	V	V
C-	-C-	-C-	-C-	V	V	V			

**10-pole Models**

Config	Label	Description											
TB 01 H		V V V V V V V V V											
TB 01 H		<table border="1" style="display: inline-table; vertical-align: middle;"> <tr> <td>V</td> <td>V</td> <td>V</td> <td>V</td> <td>V</td> <td>V</td> <td>V</td> <td>V</td> <td>V</td> <td>V</td> <td>V</td> </tr> </table>	V	V	V	V	V	V	V	V	V	V	V
V	V	V	V	V	V	V	V	V	V	V			

Config	Label	Description										
TB 02 H		$\underbrace{C-C}_{CS} \underbrace{C-C}_{CS} \underbrace{C-C}_{CS} \underbrace{C-C}_{CS} \underbrace{C-C}_{CS}$										
TB 02 H		<table border="1" style="display: inline-table; vertical-align: middle;"> <tr> <td>C-</td> <td>-C-</td> <td>C-</td> <td>-C-</td> <td>C-</td> <td>-C-</td> <td>C-</td> <td>-C-</td> <td>C-</td> <td>-C-</td> </tr> </table>	C-	-C-	C-	-C-	C-	-C-	C-	-C-	C-	-C-
C-	-C-	C-	-C-	C-	-C-	C-	-C-	C-	-C-			

Config	Label	Description										
TB 03 H		$V \underbrace{C-C}_{CS} V \underbrace{C-C}_{CS} V \underbrace{C-C}_{CS} V$										
TB 03 H		<table border="1" style="display: inline-table; vertical-align: middle;"> <tr> <td>V</td> <td>C-</td> <td>-C-</td> <td>V</td> <td>C-</td> <td>-C-</td> <td>V</td> <td>C-</td> <td>-C-</td> <td>V</td> </tr> </table>	V	C-	-C-	V	C-	-C-	V	C-	-C-	V
V	C-	-C-	V	C-	-C-	V	C-	-C-	V			

Config	Label	Description										
TB 04 H		$V V V V \underbrace{C-C}_{CS} \underbrace{C-C}_{CS} \underbrace{C-C}_{CS}$										
TB 04 H		<table border="1" style="display: inline-table; vertical-align: middle;"> <tr> <td>V</td> <td>V</td> <td>V</td> <td>V</td> <td>C-</td> <td>-C-</td> <td>C-</td> <td>-C-</td> <td>C-</td> <td>-C-</td> </tr> </table>	V	V	V	V	C-	-C-	C-	-C-	C-	-C-
V	V	V	V	C-	-C-	C-	-C-	C-	-C-			

Config	Label	Description										
TB 05 H		$V V V \underbrace{C-C}_{CS} \underbrace{C-C}_{CS} \underbrace{C-C}_{CS} V$										
TB 05 H		<table border="1" style="display: inline-table; vertical-align: middle;"> <tr> <td>V</td> <td>V</td> <td>V</td> <td>C-</td> <td>-C-</td> <td>C-</td> <td>-C-</td> <td>C-</td> <td>-C-</td> <td>V</td> </tr> </table>	V	V	V	C-	-C-	C-	-C-	C-	-C-	V
V	V	V	C-	-C-	C-	-C-	C-	-C-	V			

8. ORDERING INFORMATION

Config	Label	Description
TB 06 H		V V V $\underbrace{C-C}_{CS}$ V V $\underbrace{C-C}_{CS}$ V
TB 06 H		<span style="background-color: red; color: white;">v</span> <span style="background-color: red; color: white;">v</span> <span style="background-color: red; color: white;">v</span> <span style="border: 1px solid black; padding: 2px;">c-</span> <span style="border: 1px solid black; padding: 2px;">-c</span> <span style="background-color: red; color: white;">v</span> <span style="background-color: red; color: white;">v</span> <span style="border: 1px solid black; padding: 2px;">c-</span> <span style="border: 1px solid black; padding: 2px;">-c</span> <span style="background-color: red; color: white;">v</span>
Config	Label	Description
TB 07 H		V V $\underbrace{C-C-C-C}_{CS}$ $\underbrace{C-C-C-C}_{CS}$
TB 07 H		<span style="background-color: red; color: white;">v</span> <span style="background-color: red; color: white;">v</span> <span style="border: 1px solid black; padding: 2px;">c-</span> <span style="border: 1px solid black; padding: 2px;">-c</span> <span style="border: 1px solid black; padding: 2px;">-c</span> <span style="border: 1px solid black; padding: 2px;">-c</span> <span style="border: 1px solid black; padding: 2px;">c-</span> <span style="border: 1px solid black; padding: 2px;">-c</span> <span style="border: 1px solid black; padding: 2px;">-c</span> <span style="border: 1px solid black; padding: 2px;">-c</span>
Config	Label	Description
TB 08 H		V $\underbrace{C-C-C-C}_{CS}$ V $\underbrace{C-C-C-C}_{CS}$
TB 08 H		<span style="background-color: red; color: white;">v</span> <span style="border: 1px solid black; padding: 2px;">c-</span> <span style="border: 1px solid black; padding: 2px;">-c</span> <span style="border: 1px solid black; padding: 2px;">-c</span> <span style="border: 1px solid black; padding: 2px;">-c</span> <span style="background-color: red; color: white;">v</span> <span style="border: 1px solid black; padding: 2px;">c-</span> <span style="border: 1px solid black; padding: 2px;">-c</span> <span style="border: 1px solid black; padding: 2px;">-c</span> <span style="border: 1px solid black; padding: 2px;">-c</span>
Config	Label	Description
TB 09 H		V $\underbrace{C-C}_{CS}$ $\underbrace{C-C}_{CS}$ $\underbrace{C-C}_{CS}$ $\underbrace{C-C}_{CS}$ V
TB 09 H		<span style="background-color: red; color: white;">v</span> <span style="border: 1px solid black; padding: 2px;">c-</span> <span style="border: 1px solid black; padding: 2px;">-c</span> <span style="border: 1px solid black; padding: 2px;">c-</span> <span style="border: 1px solid black; padding: 2px;">-c</span> <span style="border: 1px solid black; padding: 2px;">c-</span> <span style="border: 1px solid black; padding: 2px;">-c</span> <span style="border: 1px solid black; padding: 2px;">c-</span> <span style="border: 1px solid black; padding: 2px;">-c</span> <span style="background-color: red; color: white;">v</span>
Config	Label	Description
TB 10 H		V V V V V V $\underbrace{C-C}_{CS}$ V
TB 10 H		<span style="background-color: red; color: white;">v</span> <span style="background-color: red; color: white;">v</span> <span style="background-color: red; color: white;">v</span> <span style="background-color: red; color: white;">v</span> <span style="background-color: red; color: white;">v</span> <span style="background-color: red; color: white;">v</span> <span style="background-color: red; color: white;">v</span> <span style="background-color: red; color: white;">v</span> <span style="border: 1px solid black; padding: 2px;">c-</span> <span style="border: 1px solid black; padding: 2px;">-c</span> <span style="background-color: red; color: white;">v</span>

**14-pole Models**

Config	Label	Description
SB 02 H		V V V V $\underbrace{T T T T T T T T}_{LF}$
SB 02 H		<span style="background-color: red; color: white;">v</span> <span style="background-color: red; color: white;">v</span> <span style="background-color: red; color: white;">v</span> <span style="background-color: red; color: white;">v</span> <span style="background-color: red; color: white;">s</span> <span style="background-color: red; color: white;">s</span> <span style="background-color: red; color: white;">s</span> <span style="background-color: red; color: white;">s</span> <span style="background-color: red; color: white;">s</span> <span style="background-color: red; color: white;">s</span> <span style="background-color: red; color: white;">s</span> <span style="background-color: red; color: white;">s</span> <span style="background-color: red; color: white;">s</span> <span style="background-color: red; color: white;">s</span> <span style="background-color: red; color: white;">t</span>

Configuration Selection Chart

Config	Label	Description															
SB 03 H		$\underbrace{C-C}_{CS} \underbrace{C-C}_{CS} \underbrace{C-C}_{CS} \underbrace{TTTTTTT}_{LF}$															
SB 03 H		<table border="1" style="display: inline-table; border-collapse: collapse;"><tr><td>C-</td><td>-C</td><td>C-</td><td>-C</td><td>C-</td><td>-C</td><td>S</td><td>S</td><td>S</td><td>S</td><td>S</td><td>S</td><td>S</td><td>S</td><td>T</td></tr></table>	C-	-C	C-	-C	C-	-C	S	S	S	S	S	S	S	S	T
C-	-C	C-	-C	C-	-C	S	S	S	S	S	S	S	S	T			
SB 04 H		$\underbrace{C-C-C-C}_{CS} \underbrace{TTTTTTT}_{LF}$															
SB 04 H		<table border="1" style="display: inline-table; border-collapse: collapse;"><tr><td>C-</td><td>-C</td><td>-C</td><td>-C</td><td>S</td><td>S</td><td>S</td><td>S</td><td>S</td><td>S</td><td>S</td><td>S</td><td>S</td><td>S</td><td>T</td></tr></table>	C-	-C	-C	-C	S	S	S	S	S	S	S	S	S	S	T
C-	-C	-C	-C	S	S	S	S	S	S	S	S	S	S	T			
SB 05 H		$\underbrace{C-C-C-C}_{CS} V V V V \underbrace{TTTTTT}_{LF}$															
SB 05 H		<table border="1" style="display: inline-table; border-collapse: collapse;"><tr><td>C-</td><td>-C</td><td>-C</td><td>-C</td><td>V</td><td>V</td><td>V</td><td>V</td><td>S</td><td>S</td><td>S</td><td>S</td><td>S</td><td>S</td><td>T</td></tr></table>	C-	-C	-C	-C	V	V	V	V	S	S	S	S	S	S	T
C-	-C	-C	-C	V	V	V	V	S	S	S	S	S	S	T			
SB 06 H		$\underbrace{C-C}_{CS} V V V V V V \underbrace{TTTTTT}_{LF}$															
SB 06 H		<table border="1" style="display: inline-table; border-collapse: collapse;"><tr><td>C-</td><td>-C</td><td>V</td><td>V</td><td>V</td><td>V</td><td>V</td><td>V</td><td>S</td><td>S</td><td>S</td><td>S</td><td>S</td><td>S</td><td>T</td></tr></table>	C-	-C	V	V	V	V	V	V	S	S	S	S	S	S	T
C-	-C	V	V	V	V	V	V	S	S	S	S	S	S	T			
SB 07 H		$\underbrace{C-C}_{CS} \underbrace{C-C}_{CS} \underbrace{C-C}_{CS} \underbrace{C-C}_{CS} \underbrace{TTTTTT}_{LF}$															
SB 07 H		<table border="1" style="display: inline-table; border-collapse: collapse;"><tr><td>C-</td><td>-C</td><td>C-</td><td>-C</td><td>C-</td><td>-C</td><td>C-</td><td>-C</td><td>S</td><td>S</td><td>S</td><td>S</td><td>S</td><td>S</td><td>T</td></tr></table>	C-	-C	C-	-C	C-	-C	C-	-C	S	S	S	S	S	S	T
C-	-C	C-	-C	C-	-C	C-	-C	S	S	S	S	S	S	T			
SB 08 H		$\underbrace{C-C-C-C}_{CS} \underbrace{C-C}_{CS} \underbrace{TTTTTTT}_{LF}$															
SB 08 H		<table border="1" style="display: inline-table; border-collapse: collapse;"><tr><td>C-</td><td>-C</td><td>-C</td><td>-C</td><td>C-</td><td>-C</td><td>S</td><td>S</td><td>S</td><td>S</td><td>S</td><td>S</td><td>S</td><td>S</td><td>T</td></tr></table>	C-	-C	-C	-C	C-	-C	S	S	S	S	S	S	S	S	T
C-	-C	-C	-C	C-	-C	S	S	S	S	S	S	S	S	T			
AB 05 H		$\underbrace{TTTTTTTTTTTTTT}_{LF}$															
AB 05 H		<table border="1" style="display: inline-table; border-collapse: collapse;"><tr><td>S</td><td>S</td><td>S</td><td>S</td><td>S</td><td>S</td><td>S</td><td>S</td><td>S</td><td>S</td><td>S</td><td>S</td><td>S</td><td>S</td><td>S</td></tr></table>	S	S	S	S	S	S	S	S	S	S	S	S	S	S	S
S	S	S	S	S	S	S	S	S	S	S	S	S	S	S			

8. ORDERING INFORMATION

Config	Label	Description
AB 06 H		V V V V V V V V V V V V V V
AB 06 H		
Config	Label	Description
AB 07 H		$\underbrace{C-C-C-C}_{CS} \underbrace{C-C-C-C}_{CS} \underbrace{C-C-C-C}_{CS} \underbrace{TT}_{LF}$
AB 07 H		

20-pole Models

Config	Label	Description
SB 09 H		$\underbrace{C-C}_{CS} \underbrace{C-C}_{CS} \underbrace{C-C}_{CS} \underbrace{C-C}_{CS} V V V V V V V V V V \underbrace{TTT}_{LF} T$
SB 09 H		

Config	Label	Description
SB 10 H		$\underbrace{C-C-C-C}_{CS} \underbrace{C-C}_{CS} V V V V V V V V V V \underbrace{TTTT}_{LF} T T T T$
SB 10 H		

Config	Label	Description
SB 11 H		$\underbrace{C-C}_{CS} \underbrace{C-C}_{CS} \underbrace{C-C}_{CS} \underbrace{C-C}_{CS} \underbrace{C-C}_{CS} \underbrace{C-C}_{CS} \underbrace{C-C}_{CS} \underbrace{C-C}_{CS} V V V V \underbrace{TT}_{LF} T T$
SB 11 H		

Config	Label	Description
SB 12 H		$\underbrace{C-C-C-C}_{CS} \underbrace{C-C-C-C}_{CS} \underbrace{C-C}_{CS} V V V V \underbrace{TTTT}_{LF} T T T T$
SB 12 H		





8. ORDERING INFORMATION

Config	Label	Description																								
SB 20 H		$\underbrace{C-C-C-C}_{CS} \underbrace{C-C-C-C}_{CS} \underbrace{TTTTTTTTTTTTTT}_{LF}$																								
SB 20 H		<table border="1" style="display: inline-table; border-collapse: collapse;"> <tr> <td>C-</td><td>-C-</td><td>-C-</td><td>-C-</td><td>C-</td><td>-C-</td><td>-C-</td><td>-C-</td><td>S</td><td>S</td><td>S</td><td>S</td><td>S</td><td>S</td><td>S</td><td>S</td><td>S</td><td>S</td><td>S</td><td>S</td><td>T</td> </tr> </table>	C-	-C-	-C-	-C-	C-	-C-	-C-	-C-	S	S	S	S	S	S	S	S	S	S	S	S	T			
C-	-C-	-C-	-C-	C-	-C-	-C-	-C-	S	S	S	S	S	S	S	S	S	S	S	S	T						
Config	Label	Description																								
SB 21 H		$\underbrace{C-C-C-C}_{CS} \underbrace{C-C-C-C}_{CS} \underbrace{C-C-C-C}_{CS} \underbrace{C-C-C-C}_{CS} \underbrace{C-C-C-C}_{CS} \underbrace{C-C-C-C}_{CS} \underbrace{VVVV}_{LF} TTTT$																								
SB 21 H		<table border="1" style="display: inline-table; border-collapse: collapse;"> <tr> <td>C-</td><td>-C-</td><td>C-</td><td>-C-</td><td>C-</td><td>-C-</td><td>C-</td><td>-C-</td><td>C-</td><td>-C-</td><td>C-</td><td>-C-</td><td>C-</td><td>-C-</td><td>V</td><td>V</td><td>V</td><td>V</td><td>S</td><td>S</td><td>S</td><td>T</td> </tr> </table>	C-	-C-	C-	-C-	C-	-C-	C-	-C-	C-	-C-	C-	-C-	C-	-C-	V	V	V	V	S	S	S	T		
C-	-C-	C-	-C-	C-	-C-	C-	-C-	C-	-C-	C-	-C-	C-	-C-	V	V	V	V	S	S	S	T					
Config	Label	Description																								
SB 22 H		$\underbrace{C-C-C-C}_{CS} \underbrace{C-C-C-C}_{CS} \underbrace{VVVV}_{LF} TTTT$																								
SB 22 H		<table border="1" style="display: inline-table; border-collapse: collapse;"> <tr> <td>C-</td><td>-C-</td><td>-C-</td><td>-C-</td><td>C-</td><td>-C-</td><td>-C-</td><td>-C-</td><td>V</td><td>V</td><td>V</td><td>V</td><td>S</td><td>S</td><td>S</td><td>S</td><td>S</td><td>S</td><td>S</td><td>S</td><td>T</td> </tr> </table>	C-	-C-	-C-	-C-	C-	-C-	-C-	-C-	V	V	V	V	S	S	S	S	S	S	S	S	T			
C-	-C-	-C-	-C-	C-	-C-	-C-	-C-	V	V	V	V	S	S	S	S	S	S	S	S	T						
Config	Label	Description																								
SB 23 H		$\underbrace{C-C-C-C}_{CS} \underbrace{C-C-C-C}_{CS} \underbrace{C-C-C-C}_{CS} \underbrace{C-C-C-C}_{CS} \underbrace{C-C-C-C}_{CS} \underbrace{C-C-C-C}_{CS} \underbrace{C-C-C-C}_{CS} \underbrace{C-C-C-C}_{CS} \underbrace{C-C-C-C}_{CS} \underbrace{C-C-C-C}_{CS} \underbrace{TT}_{LF}$																								
SB 23 H		<table border="1" style="display: inline-table; border-collapse: collapse;"> <tr> <td>C-</td><td>-C-</td><td>C-</td><td>-C-</td><td>C-</td><td>-C-</td><td>C-</td><td>-C-</td><td>C-</td><td>-C-</td><td>C-</td><td>-C-</td><td>C-</td><td>-C-</td><td>C-</td><td>-C-</td><td>C-</td><td>-C-</td><td>C-</td><td>-C-</td><td>C-</td><td>-C-</td><td>S</td><td>T</td> </tr> </table>	C-	-C-	C-	-C-	C-	-C-	C-	-C-	C-	-C-	C-	-C-	C-	-C-	C-	-C-	C-	-C-	C-	-C-	C-	-C-	S	T
C-	-C-	C-	-C-	C-	-C-	C-	-C-	C-	-C-	C-	-C-	C-	-C-	C-	-C-	C-	-C-	C-	-C-	C-	-C-	S	T			
Config	Label	Description																								
SB 24 H		$\underbrace{C-C-C-C}_{CS} \underbrace{C-C-C-C-C-C}_{CS} \underbrace{C-C-C-C-C-C}_{CS} \underbrace{TTTTTTTTTT}_{LF}$																								
SB 24 H		<table border="1" style="display: inline-table; border-collapse: collapse;"> <tr> <td>C-</td><td>-C-</td><td>-C-</td><td>-C-</td><td>C-</td><td>-C-</td><td>-C-</td><td>-C-</td><td>C-</td><td>-C-</td><td>-C-</td><td>-C-</td><td>S</td><td>S</td><td>S</td><td>S</td><td>S</td><td>S</td><td>S</td><td>S</td><td>S</td><td>S</td><td>T</td> </tr> </table>	C-	-C-	-C-	-C-	C-	-C-	-C-	-C-	C-	-C-	-C-	-C-	S	S	S	S	S	S	S	S	S	S	T	
C-	-C-	-C-	-C-	C-	-C-	-C-	-C-	C-	-C-	-C-	-C-	S	S	S	S	S	S	S	S	S	S	T				
Config	Label	Description																								
SB 25 H		$\underbrace{C-C-C-C}_{CS} \underbrace{C-C-C-C-C-C}_{CS} \underbrace{C-C-C-C-C-C}_{CS} \underbrace{C-C-C-C-C-C}_{CS} \underbrace{TTTT}_{LF}$																								
SB 25 H		<table border="1" style="display: inline-table; border-collapse: collapse;"> <tr> <td>C-</td><td>-C-</td><td>-C-</td><td>-C-</td><td>C-</td><td>-C-</td><td>-C-</td><td>-C-</td><td>C-</td><td>-C-</td><td>-C-</td><td>-C-</td><td>C-</td><td>-C-</td><td>-C-</td><td>-C-</td><td>S</td><td>S</td><td>S</td><td>T</td> </tr> </table>	C-	-C-	-C-	-C-	C-	-C-	-C-	-C-	C-	-C-	-C-	-C-	C-	-C-	-C-	-C-	S	S	S	T				
C-	-C-	-C-	-C-	C-	-C-	-C-	-C-	C-	-C-	-C-	-C-	C-	-C-	-C-	-C-	S	S	S	T							
Config	Label	Description																								
SB 26 H		$\underbrace{C-C-C-C}_{CS} \underbrace{C-C-C-C}_{CS} \underbrace{C-C-C-C}_{CS} \underbrace{C-C-C-C}_{CS} \underbrace{VVVV}_{LF} TTTT$																								
SB 26 H		<table border="1" style="display: inline-table; border-collapse: collapse;"> <tr> <td>C-</td><td>-C-</td><td>C-</td><td>-C-</td><td>C-</td><td>-C-</td><td>C-</td><td>-C-</td><td>V</td><td>V</td><td>V</td><td>V</td><td>S</td><td>S</td><td>S</td><td>S</td><td>S</td><td>S</td><td>S</td><td>S</td><td>S</td><td>T</td> </tr> </table>	C-	-C-	C-	-C-	C-	-C-	C-	-C-	V	V	V	V	S	S	S	S	S	S	S	S	S	T		
C-	-C-	C-	-C-	C-	-C-	C-	-C-	V	V	V	V	S	S	S	S	S	S	S	S	S	T					

Config	Label	Description																					
SB 27 H		$\underbrace{C-C-C-C}_{CS} \underbrace{C-C}_{CS} V V V V \underbrace{T T T T T T T T T T}_{LF}$																					
SB 27 H		<table border="1"> <tr> <td>C-</td><td>-C-</td><td>-C-</td><td>-C</td><td>C-</td><td>-C</td> <td>V</td><td>V</td><td>V</td><td>V</td> <td>S</td><td>S</td><td>S</td><td>S</td><td>S</td><td>S</td><td>S</td><td>S</td><td>S</td><td>S</td><td>T</td> </tr> </table>	C-	-C-	-C-	-C	C-	-C	V	V	V	V	S	S	S	S	S	S	S	S	S	S	T
C-	-C-	-C-	-C	C-	-C	V	V	V	V	S	S	S	S	S	S	S	S	S	S	T			

Config	Label	Description																						
AB 08 H		V V																						
AB 08 H		<table border="1"> <tr> <td>V</td><td>V</td><td>V</td><td>V</td><td>V</td><td>V</td><td>V</td><td>V</td><td>V</td><td>V</td><td>V</td><td>V</td><td>V</td><td>V</td><td>V</td><td>V</td><td>V</td><td>V</td><td>V</td><td>V</td><td>V</td><td>V</td> </tr> </table>	V	V	V	V	V	V	V	V	V	V	V	V	V	V	V	V	V	V	V	V	V	V
V	V	V	V	V	V	V	V	V	V	V	V	V	V	V	V	V	V	V	V	V	V			

Config	Label	Description																				
AB 09 H		$\underbrace{C-C-C-C}_{CS} \underbrace{C-C-C-C}_{CS} \underbrace{C-C-C-C}_{CS} \underbrace{C-C-C-C}_{CS} \underbrace{C-C-C-C}_{CS}$																				
AB 09 H		<table border="1"> <tr> <td>C-</td><td>-C-</td><td>-C-</td><td>-C</td><td>C-</td><td>-C-</td><td>-C-</td><td>-C</td><td>C-</td><td>-C-</td><td>-C-</td><td>-C</td><td>C-</td><td>-C-</td><td>-C-</td><td>-C</td><td>C-</td><td>-C-</td><td>-C-</td><td>-C</td> </tr> </table>	C-	-C-	-C-	-C	C-	-C-	-C-	-C	C-	-C-	-C-	-C	C-	-C-	-C-	-C	C-	-C-	-C-	-C
C-	-C-	-C-	-C	C-	-C-	-C-	-C	C-	-C-	-C-	-C	C-	-C-	-C-	-C	C-	-C-	-C-	-C			

Config	Label	Description																						
AB 10 H		$\underbrace{T T}_{LF}$																						
AB 10 H		<table border="1"> <tr> <td>S</td><td>S</td><td>S</td><td>S</td><td>S</td><td>S</td><td>S</td><td>S</td><td>S</td><td>S</td><td>S</td><td>S</td><td>S</td><td>S</td><td>S</td><td>S</td><td>S</td><td>S</td><td>S</td><td>S</td><td>S</td><td>S</td> </tr> </table>	S	S	S	S	S	S	S	S	S	S	S	S	S	S	S	S	S	S	S	S	S	S
S	S	S	S	S	S	S	S	S	S	S	S	S	S	S	S	S	S	S	S	S	S			

---

**North America**

SecuControl Inc.  
2873 Duke Street  
Alexandria, VA 22314  
USA  
Tel +1 703 838 7677  
mail@secucontrol.com  
www.secucontrol.com

**Europe**

SecuControl GmbH  
Ascherslebener Str. 3  
D-06333 Hettstedt  
Germany  
Tel +49 3476 550 022  
info@secucontrol.com  
www.secucontrol.com

**South America**

SecuBrasil Ltda  
Rod José Carlos Daux, 8600  
88050-001 Florianópolis SC  
Brazil  
Tel +55 (48) 3371 1670  
comercial@secubrasil.com  
www.secubrasil.com